

# Slim Aluminium Roofs

## Assembly Guide

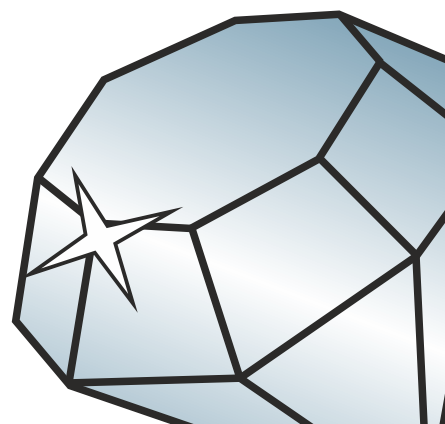

DURATION  
WINDOWS



# Contents

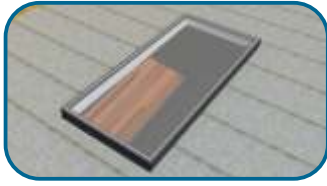

Slim Flush glazed roofs  
Page 3



Single section of glass  
Page 4

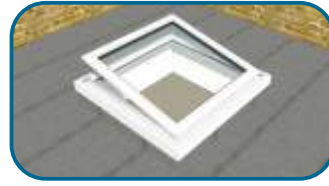

Single square with opener  
Page 5



Multiple glass panes  
Page 6

Installing Openers  
Page 10

## Timber Kerb For Flat Roofs With Fixed Glazing

- Create the appropriate kerb\* for the flat roof light to be fitted to.
- The kerb\* must be pre-weathered with a minimum 2.5° pitch to enable water run off.
- Ensure your kerb\* details are square and check diagonals are all equal. If it is not square your roof will not fit.
- The finished external kerb size including roofing material should be a minimum of 10mm smaller in the overall width & length than the roof purchased.

\* Kerb not supplied by Duration Windows.

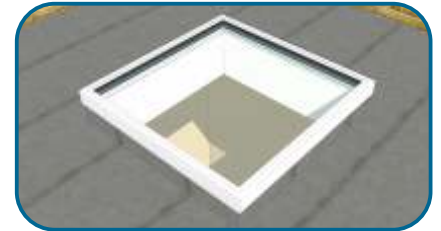
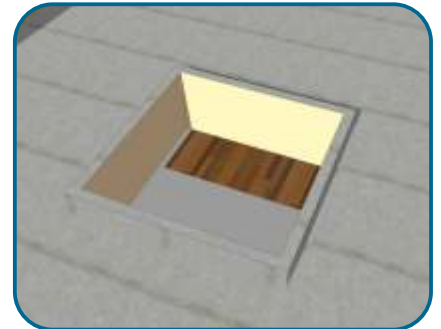
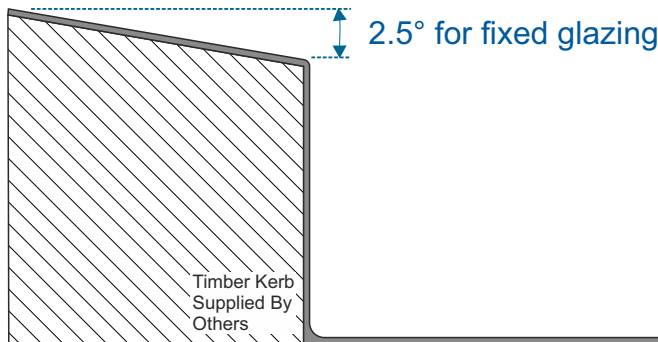

- This kerb detail is for all slim roofs using fixed glazing with a single section of glass, multiple glazed panels divided by transoms or bonded flush glazed units.

## Timber Kerb For Flat Roofs With Opening Lights

- Create the appropriate kerb\* for the flat roof light to be fitted to.
- The kerb\* must be pre-weathered with a minimum 7.5° pitch to enable water run off.
- Ensure your kerb\* details are square and check diagonals are all equal. If it is not square your roof will not fit.
- The finished external kerb size including roofing material should be a minimum of 10mm smaller in the overall width & length than the roof purchased.

\* Kerb not supplied by Duration Windows.

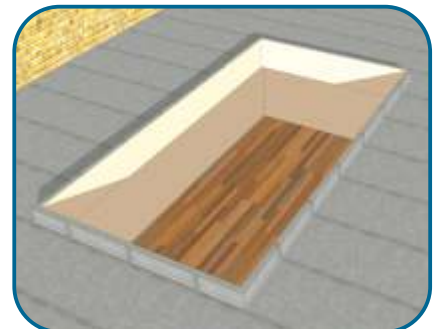
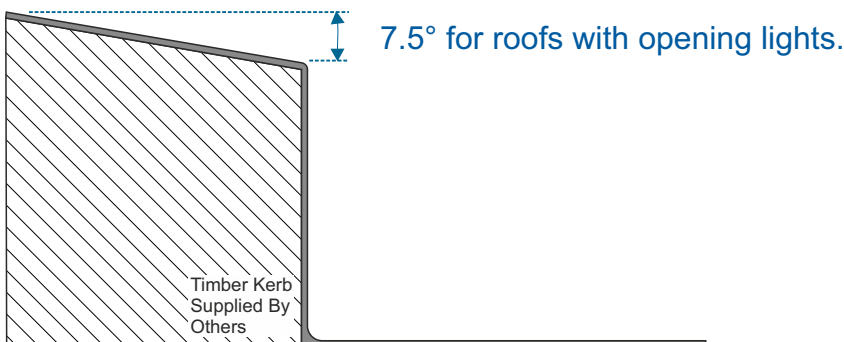

# Single Section Of Glass - Slim Flush



1 All flush glazed flat roof lights will come fully made up and glazed from the factory.

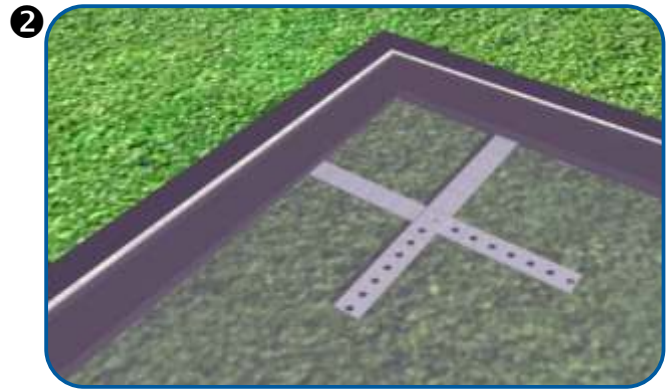

2 Fixing lugs will come pre-fitted to the roof.

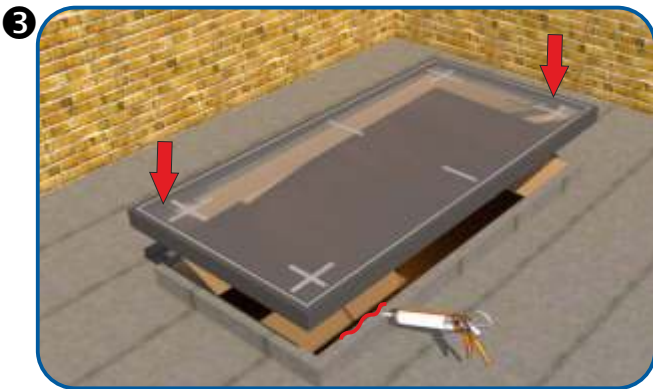

3 Bed the roof down with an appropriate sealant onto your timber kerb with finished roof material.

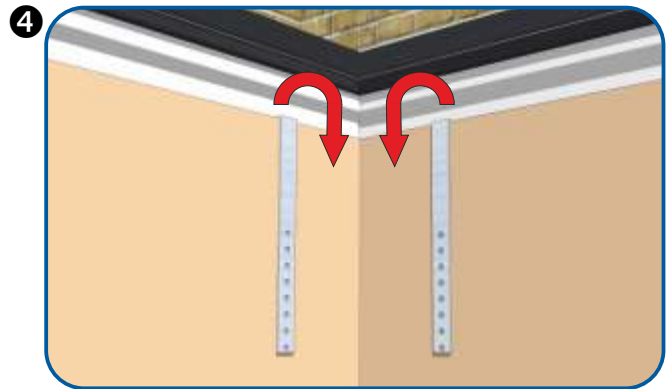

4 Once bed down, bend the fixing lugs over your kerb edges. Any excess lug can be removed if needed. In most cases this will be done before the plaster board is on.

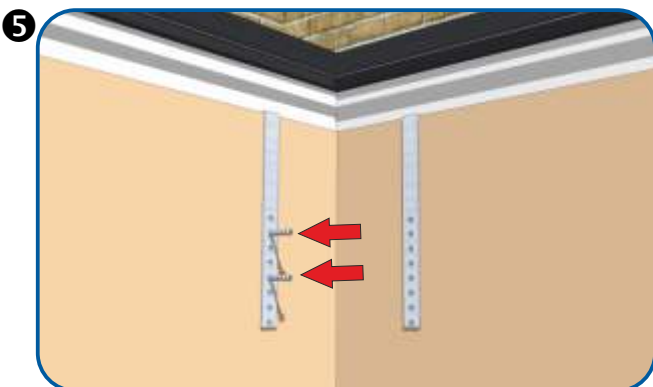

5 Screw fix using appropriate screws for site. Use at least two fixings per lug - more can be used if needed.

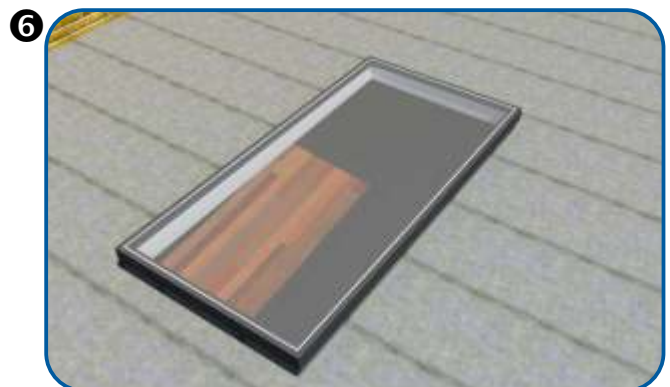

6 Finish off appropriate to site needs. In most builds this will be by applying plaster board and plastering and applying trim where needed.



# Single Section Of Glass - No Transoms

## Beaded System With No Transoms



1 All flat roof lights with a single section of glass will come fully made up and glazed from the factory.

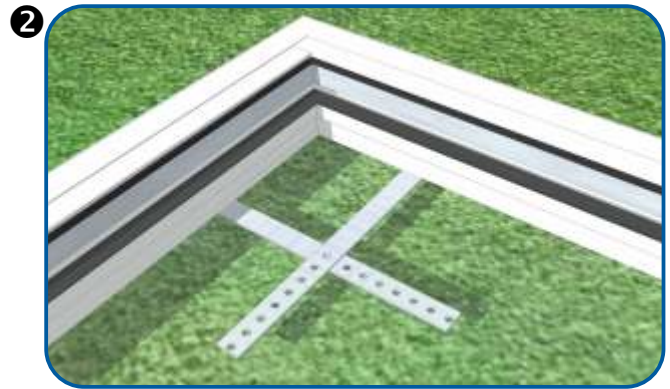

2 Fixing lugs will come pre-fitted to the roof.

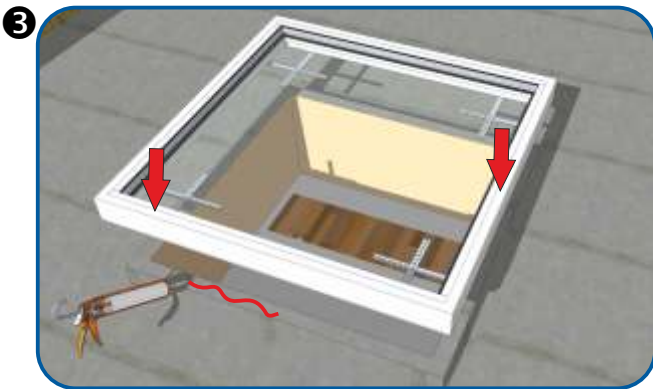

3 Bed the roof down with an appropriate sealant onto your timber kerb with finished roof material.

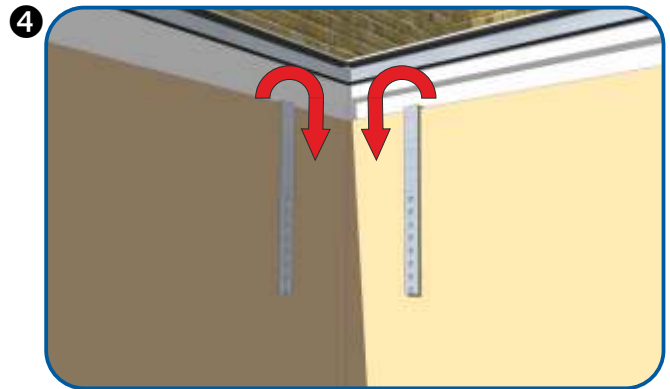

4 Once bed down, bend the fixing lugs over your kerb edges. Any excess lug can be removed if needed. In most cases this will be done before the plaster board is on.

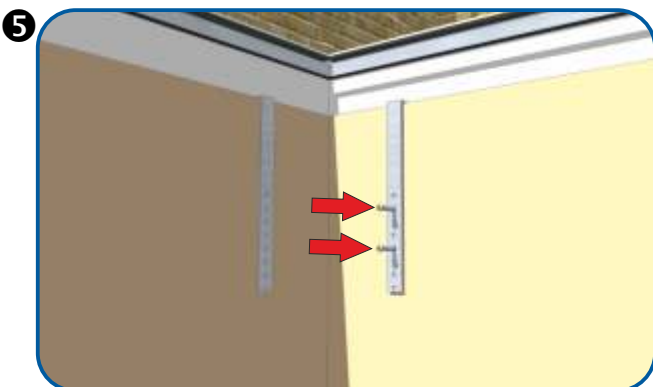

5 Screw fix using appropriate screws for site. Use at least two fixings per lug - more can be used if needed.

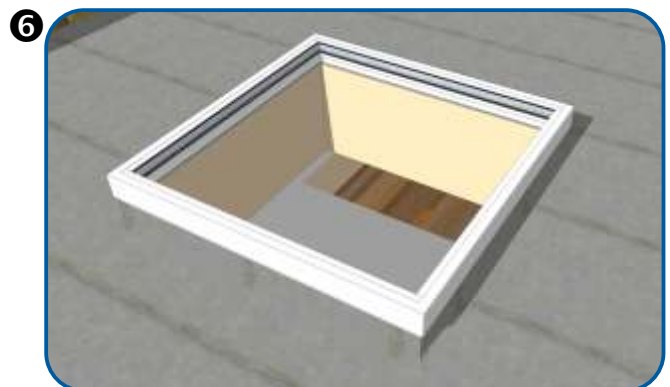

6 Finish off appropriate to site needs. In most builds this will be by applying plaster board and plastering and applying trim where needed.

# Square Roof With Opener - No Transoms

## Beaded System With No Transoms



1 All square flat roofs with openers as above will come factory finished and ready to install.

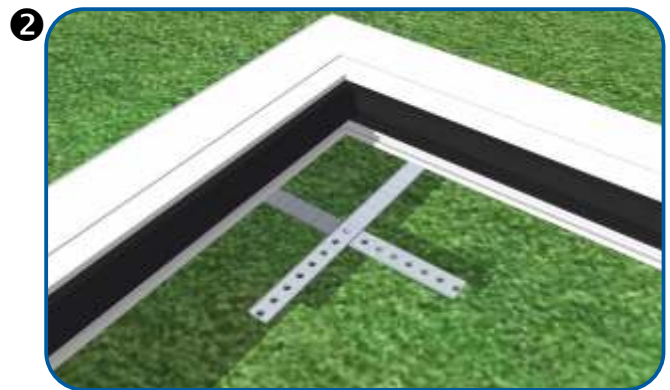

2 Fixing lugs will come pre-fitted to the roof.

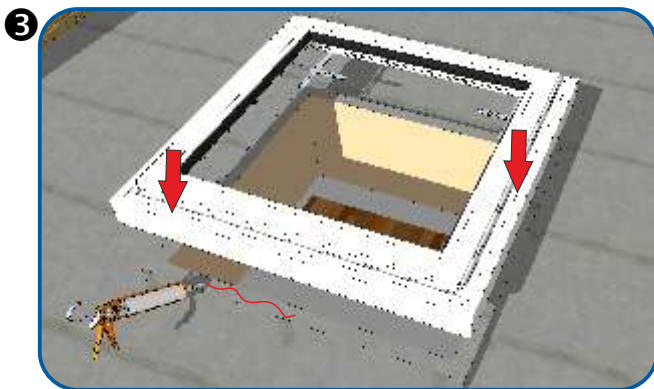

3 Bed the roof down with an appropriate sealant onto your timber kerb with finished roof material.

Note the opening device will go to the lower part of the pitch.

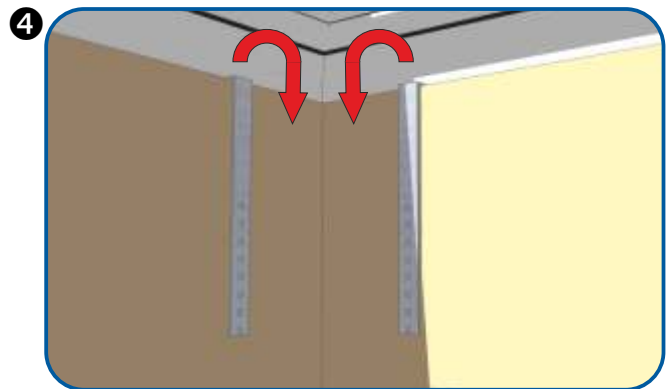

4 Once bed down, bend the fixing lugs over your kerb edges. Any excess lug can be removed if needed.

In most cases this will be done before the plaster board is on.

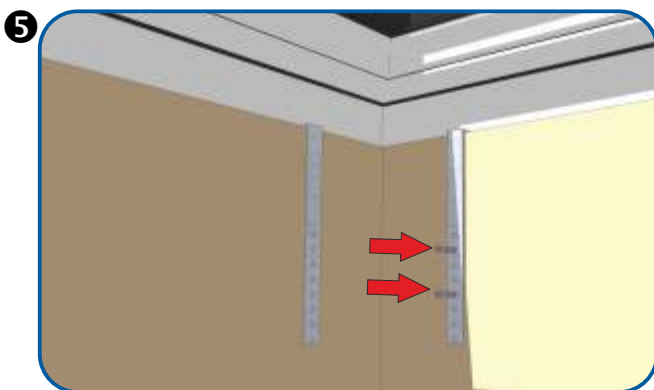

5 Screw fix using appropriate screws for site. Use at least two fixings per lug - more can be used if needed.

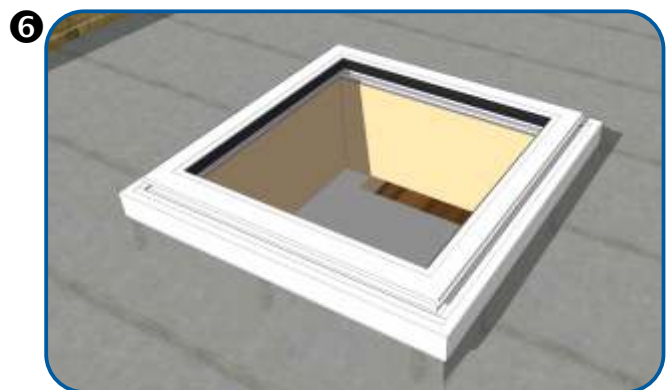

6 Finish off appropriate to site needs. In most builds this will be by applying plaster board and plastering and applying trim where needed.

**For opening lights that use an electric motor see extra wiring details on page 1 1.**



# Multiple Glazed Sections - With Transoms

## Beaded System With Transoms

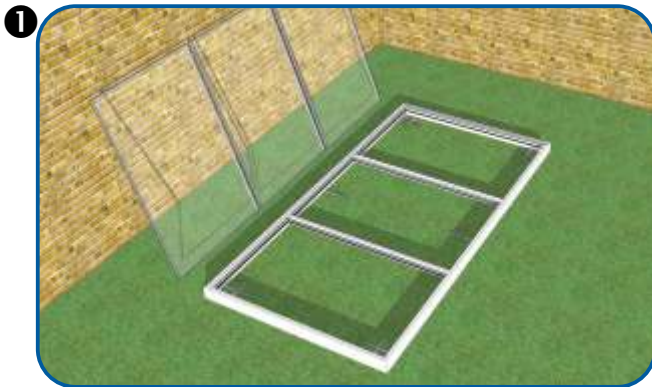

1  
Roofs with multiple glazed sections will come delivered with the glass separate. Please note that transoms are not secured in place and the labels on the units will identify which way up to glaze the product later. Once glazed the stickers can be removed.

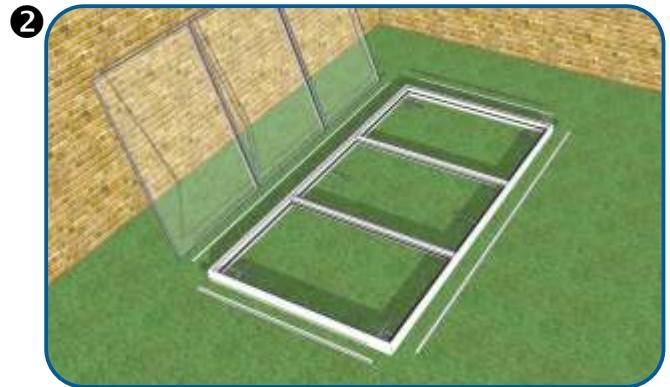

2  
Remove the short cut beads then remove the long cut beads. Note where each bead is removed from so they can be re-installed into the same positions later.

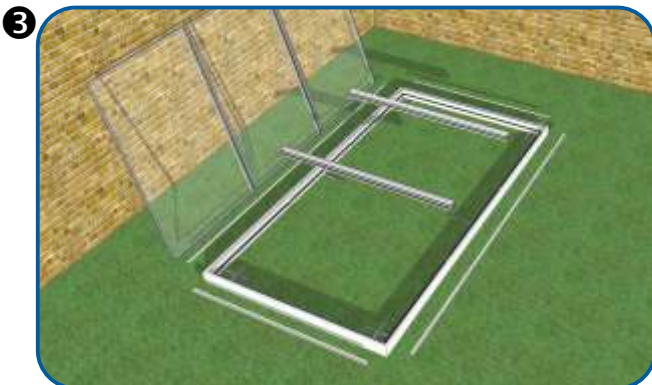

3  
Now remove the transom beads and then the actual transoms. Note where each of these parts are taken from so they can go back into the same place. Transoms are not fixed so are easily removed.



4  
Fixing lugs will come pre-fitted to the roof. Bed the roof down with an appropriate sealant onto your timber kerb with finished roof material. Check all silicone joints on the mitres are not broken etc. Apply more silicone if needed in this area.

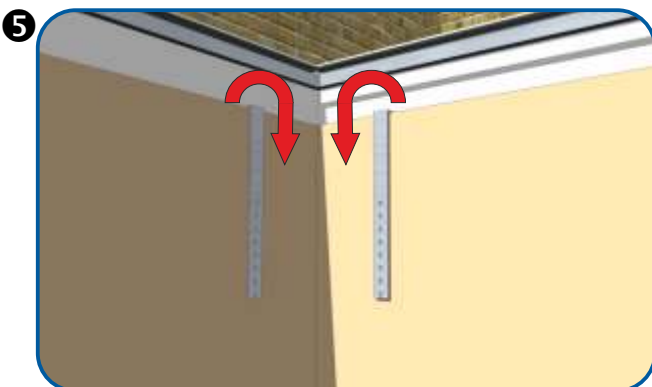

5  
Once bed down, bend the fixing lugs over your kerb edges. Any excess lug can be removed if needed. In most cases this will be done before the plaster board is on.

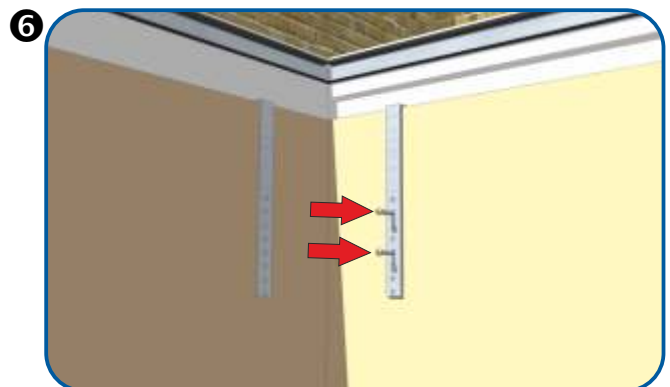

6  
Screw fix using appropriate screws for site. Use at least two fixings per lug - more can be used if needed.

# Multiple Glazed Sections - With Transoms

## Glazing Multiple Sections With Transom Divides



1 Place a silicone seal along transom rebate which is cut out of the outer frame. Do this on both sides of the roof.

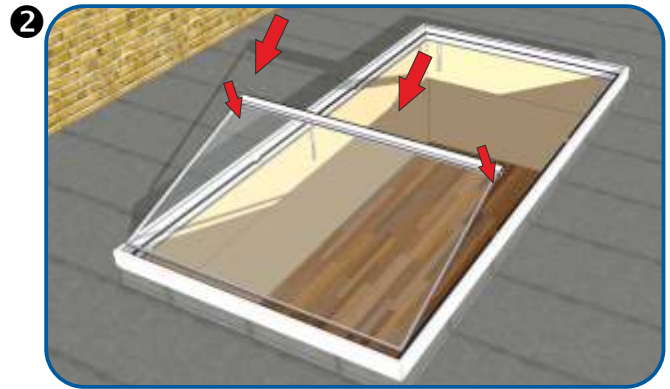

2 Slip transom onto glass. Make sure the beaded side of the transom is to the centre. Lay glazed unit with transom into place. Make sure the transom beds down onto the silicone seal placed in the step before.

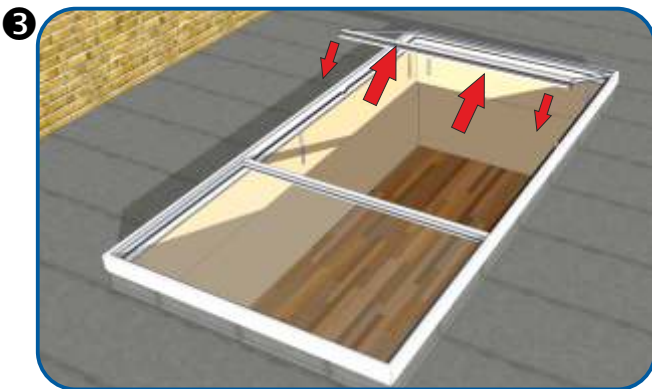

3 Again silicone the next transom slot. Slip transom onto glass. Make sure the beaded side of the transom is to the centre. Lay glazed unit with transom into place. Make sure the transom beds down onto the silicone seal placed in the pre-cut slot.

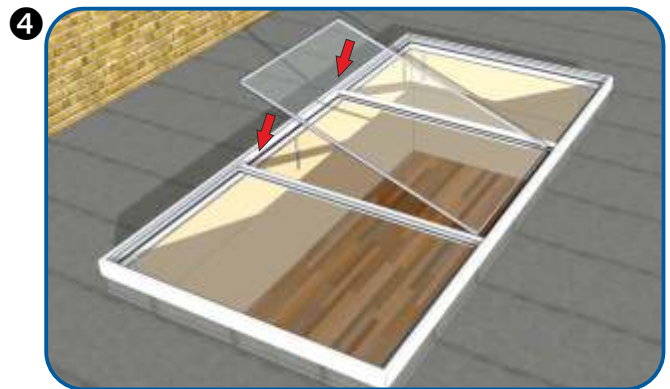

4 Once all transoms are in place with the glazed units the final unit can be positioned as shown.

# Multiple Glazed Sections - With Transoms

## Beads & Gaskets

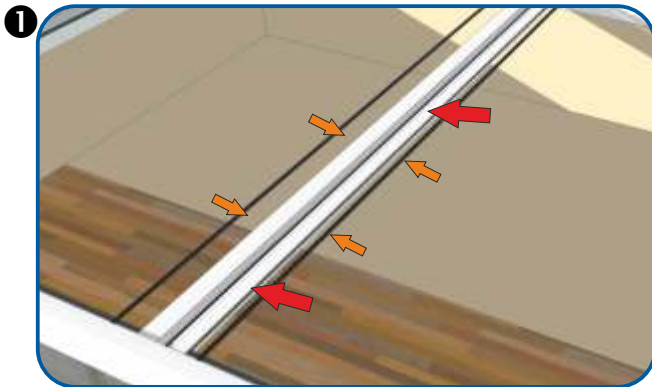

1 Start by clipping all beads into the transoms. Once all beads are clipped into place you can then gasket them. This will tighten the beads up and secure everything in place.

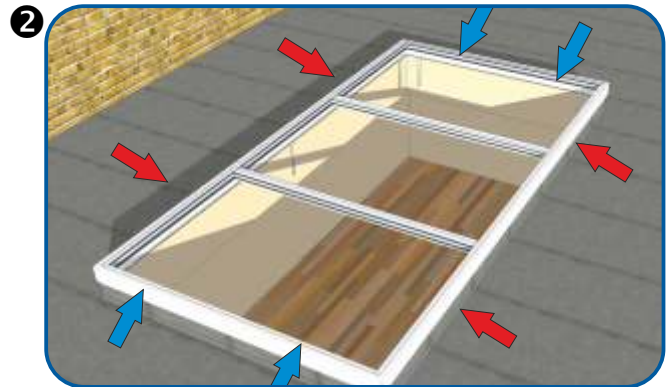

2 Once the transom beads and gaskets are in position you can move on to the other beads. Clip the long cut beads into place (red arrows). Then clip the short cut beads into place (blue arrows).

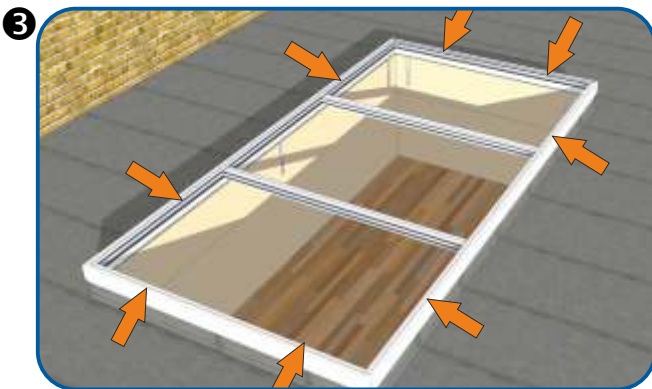

3 Once all beads are in place you can now wedge gasket the roof to all 4 sides.

**Please see drainage details on page 9 before gasketing the roof.**

Note wedge gaskets will be cut where the transoms meet the beads.

Wedge gaskets will tighten the beads up and secure everything in place.

The wedge gaskets are designed to be tight but if they prove difficult try some of the following methods:

1. Use some glass cleaner to help slide the gaskets into place.
2. Warm the gaskets in warm water.

When placing the gaskets always push directly towards the bead / transom - this will ensure the gaskets are not over stretched which may lead to gaps when they cool and retract back.



# Drainage For Beaded Flat Roofs

## Drainage Details

Drainage slots would have been installed into the roofs at the factory and are provided on all 4 sides.

You will need to remove some sections of gasket between the beads so that water can access this drainage path. In the case of a single section of glass roof this should already be done in the factory (please check). On a multiple glazed roof this will need to be done by the installer.

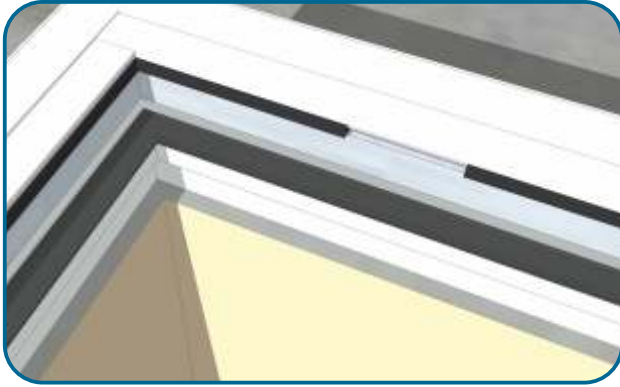

To minimise standing water remove a 50mm section of gasket to allow water to access the drainage path.

These slots should start at approximately 100mm in from the corners or any transom.

In cases of larger roofs more slots may need to be added.

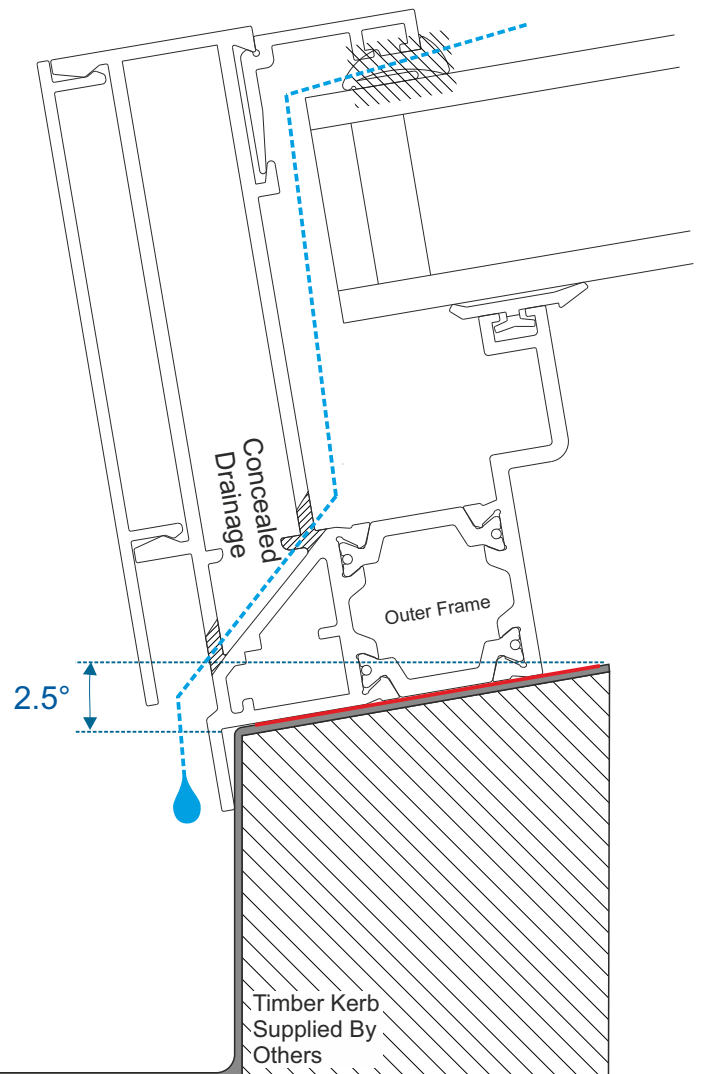
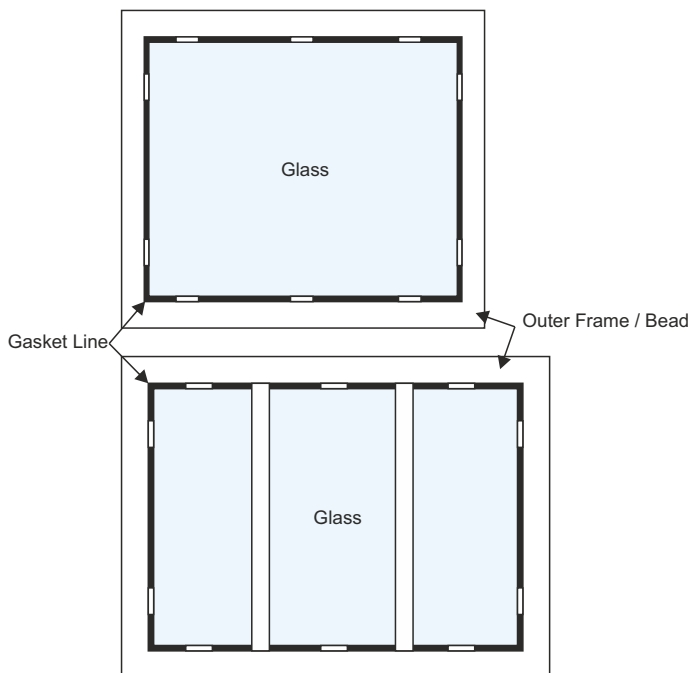

# Roof Vents

## Installing A Roof Vent

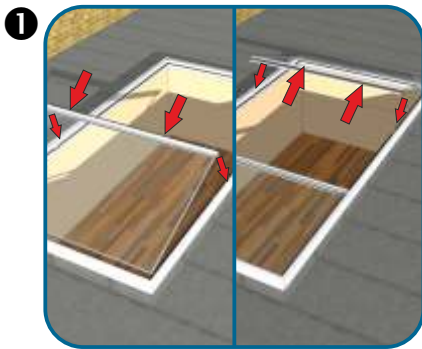

- 1 Assemble roof as per original instructions.
- 2 Try and make sure the opener goes to the beaded section of the transoms where possible.
- 3 Glaze other areas as normal.

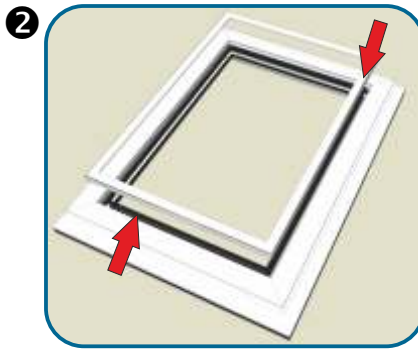

- 2 Roof vent/s will come pre-assembled and unglazed.
- 3 Remove beads.
- 4 Please seal all joints on site for weather tightness

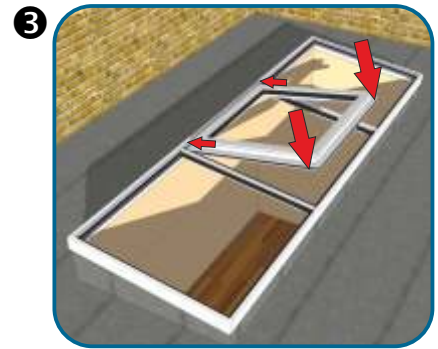

- 3 Lay opener into position between the transom bars. This should rest on the gaskets on all 4 sides.

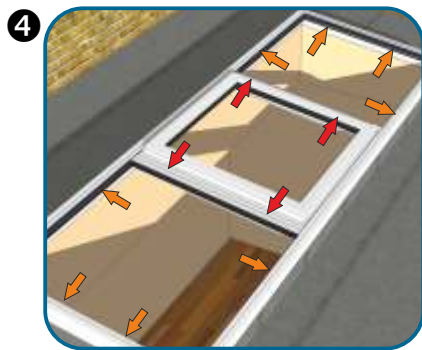

- 4 Insert beads and gaskets to transom bars.
- 5 Then bead and gasket the main roof.

These processes are done in the same way as on page 8 when using just glass.

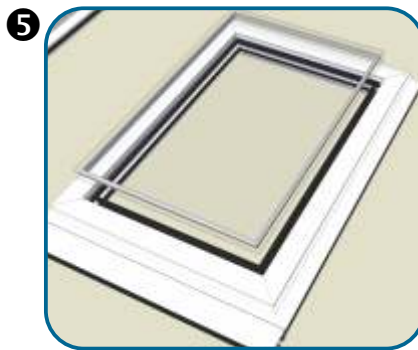

- 5 Glazing the opener.
- 6 Insert glazed unit into roof vent.

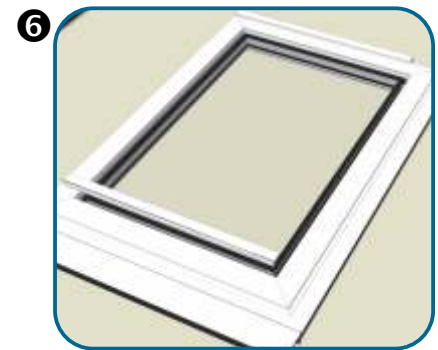

- 6 Snap top and bottom beads into place.

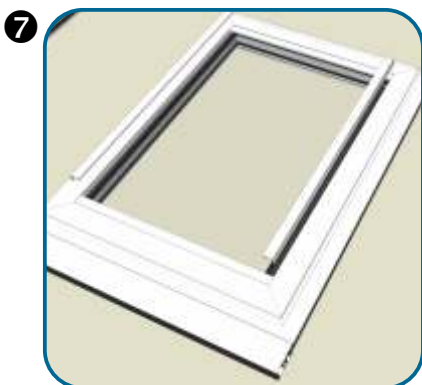

- 7 Snap side beads into place.

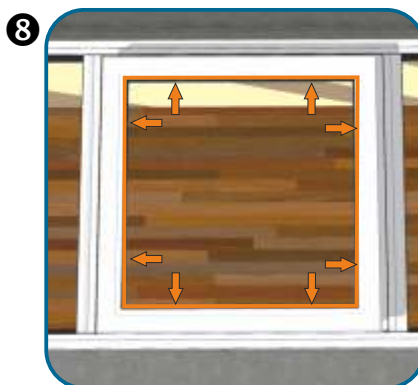

- 8 Wedge gasket into place between the glass and bead.

For opening lights that use an electric motor see extra wiring details on page 11.

# Roof Vents

If in doubt contact a qualified electrician.

## The Motor

## Electric Wiring To Rocker Switch



	ACK42	ACK44
Power supply voltage	230 V	24 V ===
Absorbed current	0.32 A	2.1 A
Absorbed power with load	75 W	32 W
Absorbed power with load	300N	300N
Stroke	100 - 400mm adjustable	100 - 400mm adjustable
Wiring	3 core	2 core
Double insulated	Yes	No
Protection against electric shocks	Class II	Class II
Protection degree of electric devices	IP 55	IP 55
Weight	1.9kg	1.9kg

Both have buzzer to indicate wrong installation

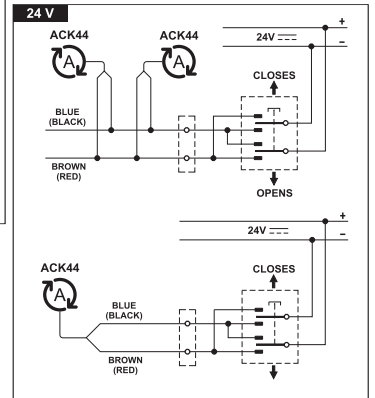
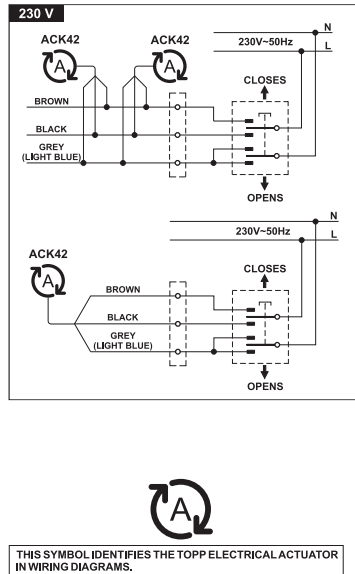

## Heat & Rain Sensor

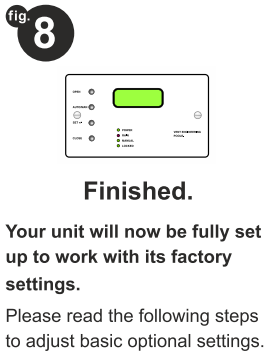
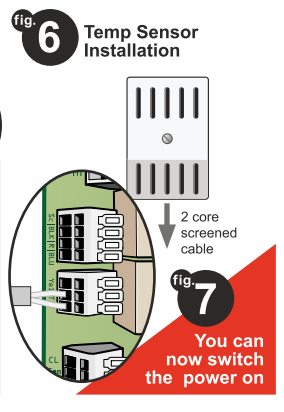
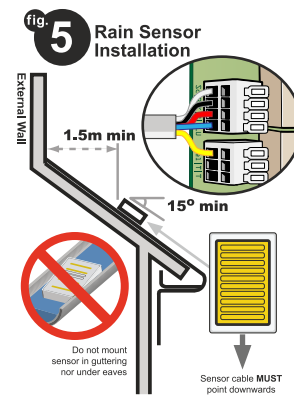
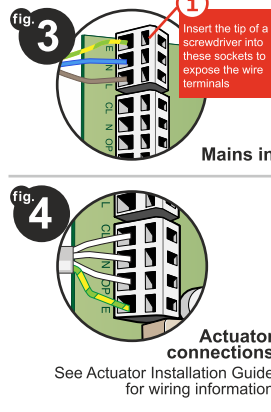
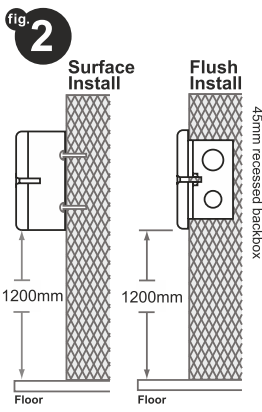
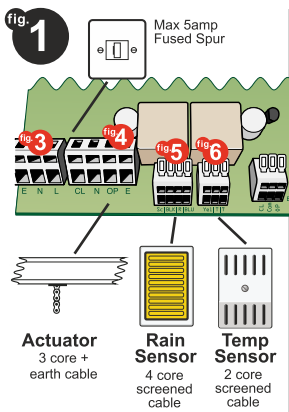

### Additional user settings

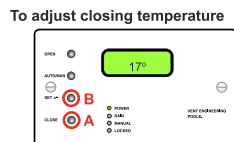
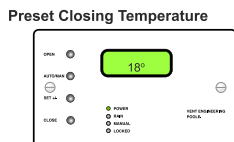
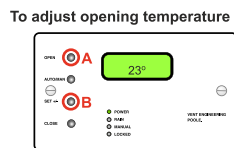
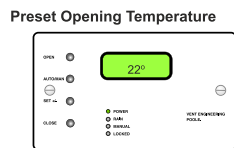

**To manually open and close**

Press and hold **AUTO/MAN** for 2 seconds until **MANUAL** light comes on then use the **OPEN** or **CLOSE** buttons to adjust the window position.

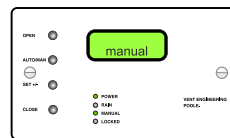

Press and hold **AUTO/MAN** for 2 seconds to return to automatic mode.

We advise a difference of at least 2° between the opening and closing temperature.

### Q. Where do I mount my temperature sensor?

- A. This location is entirely at your discretion. We would recommend a position that gives a good average reading of the desired location, ideally at least 1300mm from the floor.
- You can choose to position the thermostat a maximum of 30m away from the control panel.

### Q. My display shows 0.0 - Is this correct?

- A. This indicates a problem with the thermostat wiring. Check the wiring and that all connections have been correctly made.





### **Main Office & Factory**

Units 4-5,                    t: 01268 681612 (15 lines)  
Charfleets Road,        f: 01268 510058  
Canvey Island,         e: sales@duration.co.uk  
Essex. SS8 0PQ         w: www.duration.co.uk

### **Product Showroom**

Unit 1 Casino Parade,    t: 01268 695100  
Eastern Esplanade,  
Canvey Island,            SatNav Directions  
Essex. SS8 7FJ            Use: SS8 7DN.