

# Emperor Concealed

## Assembly Guide

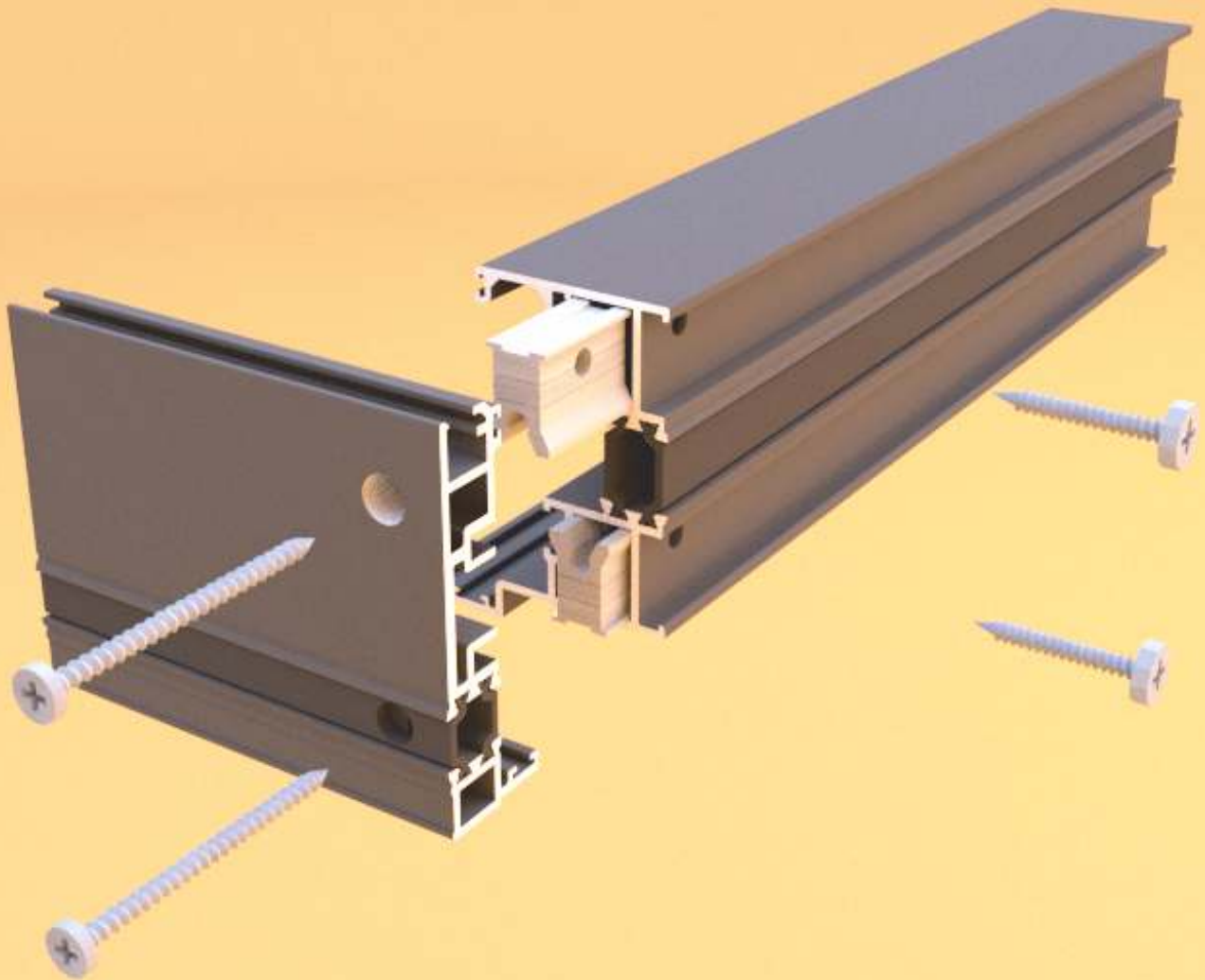

DURATION  
WINDOWS



# Low Threshold Clip In Cill

**KIT FORM ONLY!**

If selected, it is recommended to fix the clip in cill prior to installation.

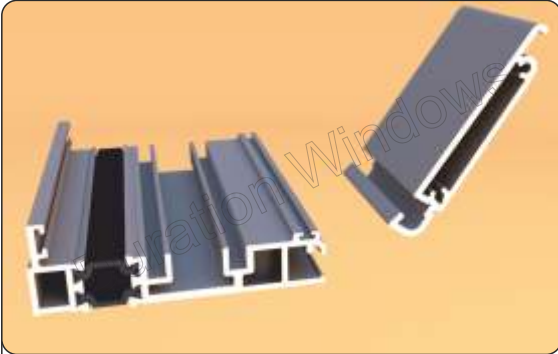

Offer the clip in cill up to the low threshold at an angle.



Locate the cill into the cavity.



Lever the cill down into position.



**CLICK!**

It will need to be clicked into final position.

**ALTERNATIVELY!**



Cill can also be slid into the threshold and clicked in place.

# Manual Blinds - Handling & Installation

Blinds are manufactured with all slats closed at the head track; **on NO account should they be tilted or lowered until the unit is correctly installed in the frame.**

Blind units should be transported either with the closed slats at the top or bottom of the unit, they can be transported on their sides with care. **On NO account should they be laid flat.**

All blind units are gas filled and fully operational before being dispatched.

The operating system is powered by magnets and **on NO account should the magnet controllers be removed from the glass surface until the unit is installed correctly in the frame.**

When operating for the first time, lower the blind to its full extent, using the tilt controller; always ensure that the slats are in the horizontal position before using the lift and drop controller.

The controllers should not be forced beyond their magnetic connection and are not interchangeable.

When the unit is in the frame and before the final bead and gasket is applied, select the operating position for the controllers, these need to be in alignment with the blind jamb sections.

These procedures are to assist in the transportation, installation and operation of these products.



# Electronic Blinds - Handling & Installation

Blinds are manufactured with all slats closed at the head track; **on NO account should they be lowered until the unit is correctly installed in the frame.**

All blind units are gas filled and **fully operational** before being dispatched.

The battery controller is powered to capacity at manufacture but should be re-charged on site before attempting to operate the blind.

The battery controller power source should be charged as required from the UK mains house supply, this supply is reduced to 12 volts for safe operation.

Each unit will have a short cable exiting at the side of the head track, a female connector is attached and a longer cable is attached to the power plate with a male connector.

When the unit is in the frame and before the final bead and gasket is applied, select the operating position for the controller before applying the power plate to the glass.

The blinds power plate should be fixed to the internal glass surface, the glass must be cleaned before applying the self adhesive power plate.

The fully charged controller should be placed on the power plate, the controller is held in place by magnetic force.



# Drainage

When installing a bifold, drainage paths for the threshold need to be taken into consideration.

Please discuss drainage with the bifold installer, homeowner and external flooring installer.

The below images depict an example of each threshold and its drainage path.

**Lead Flashing or DPC  
Supplied By Others.**

Standard Rebated No Cill (Open Out)

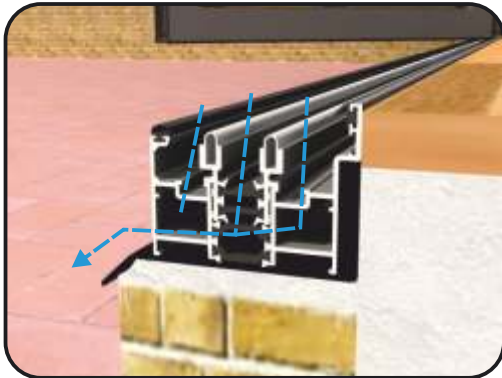

Standard Rebated With Cill (Open Out)

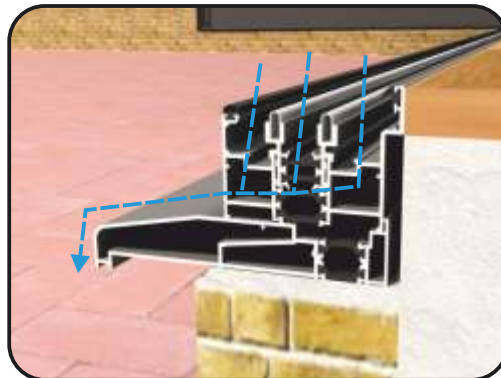

Low Rebated No Cill (Open Out)

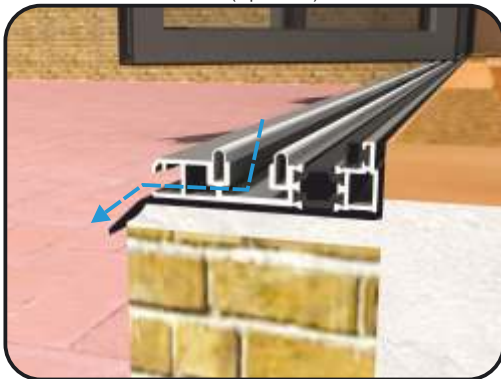

Low Rebated With Clip In Cill (Open Out)

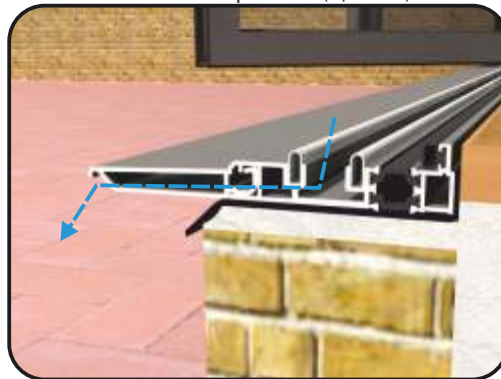

Low Rebated With Separate Cill (Open Out)

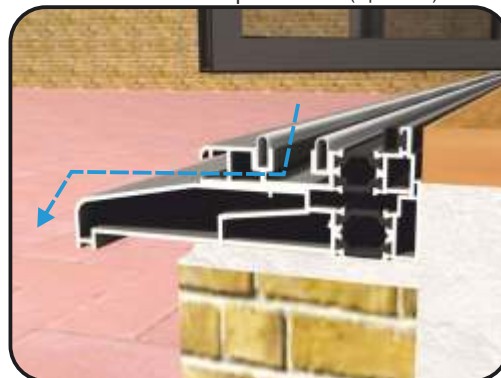

# Outer Frame Assembly (Standard Threshold)

**KIT FORM ONLY!**

**IMPORTANT:** Remember to silicone each corner joint prior to final fixing.



Cleats are positioned into the frame. Make sure the mitre is sealed with silicone or small gap sealer before assembling.

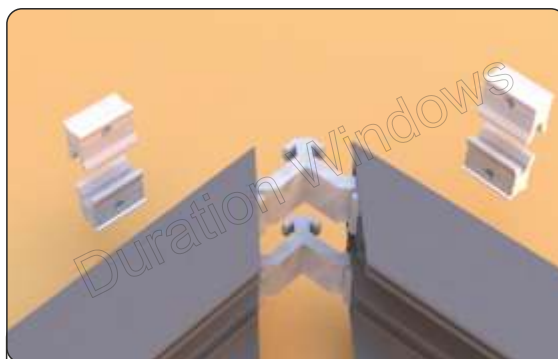

Use a 3mm allen key to tighten inserted blocks. Make sure the mitre is sealed with silicone or small gap sealer before assembling.

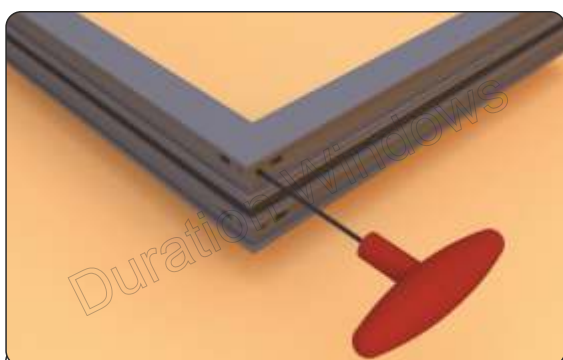

Insert the blocks with the allen key screw facing the round hole. Use a 3mm allen key to tighten up the mitre.

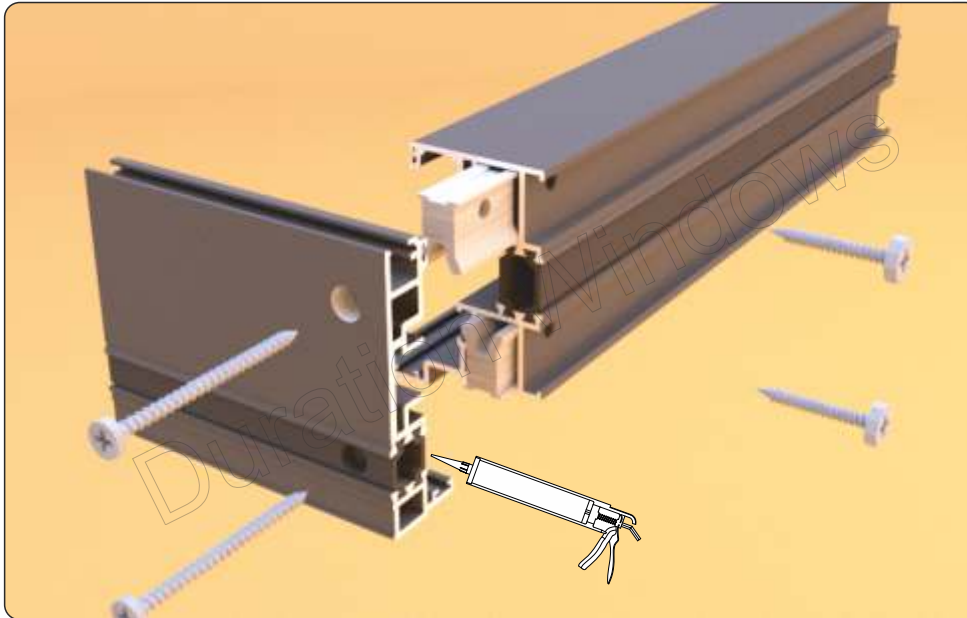

Image shows how the mitre will look once assembled correctly.

# Outer Frame Assembly (Low Threshold)

**KIT FORM  
ONLY!**

Top and jambs are assembled as normal outer frame (page 7).



Position low threshold under jambs.

Make sure to silicone edges.

Insert jamb plus into the rebated frame.

Make sure to silicone edges.

Tighten fixings evenly.

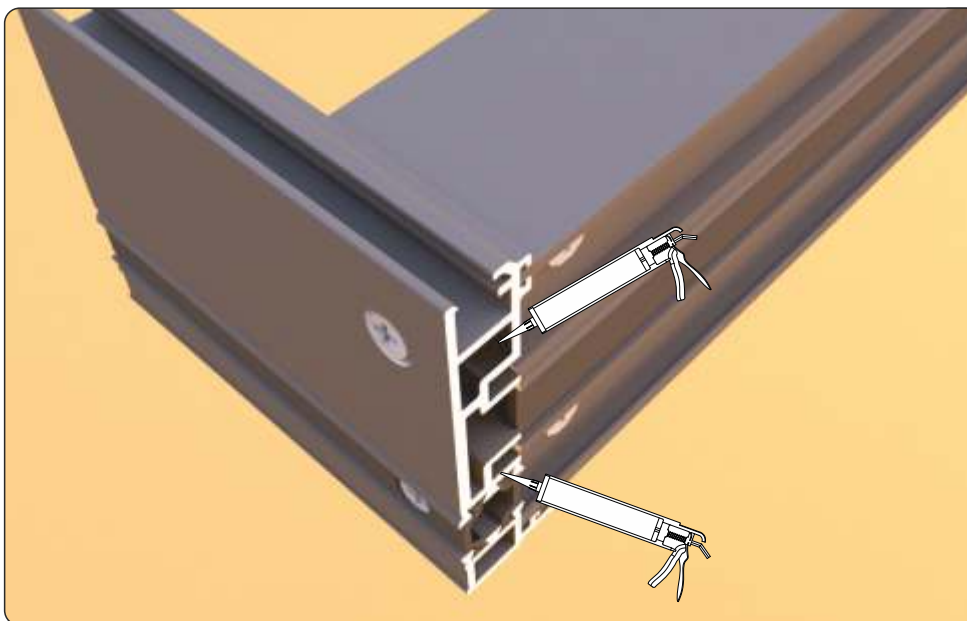

Once assembled finally pump silicone into any spaces between the threshold and frame.

**IMPORTANT:** Remember to silicone each corner joint prior to final fixing.



# Fitting Internal Glazing Bead

The Emperor glazing bead is a snug fit. Start in a corner and apply firm pressure when fitting.

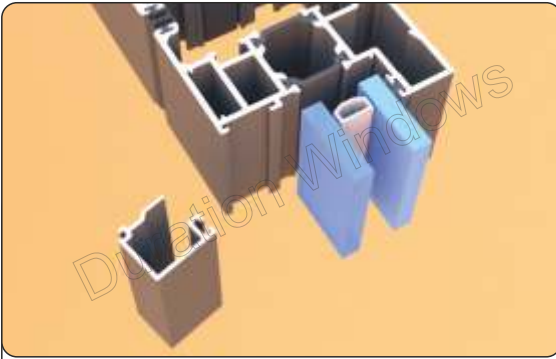

Starting in a corner, offer bead to the panel at a slight angle.



Still angled, locate the bead's top lip into the frame pocket

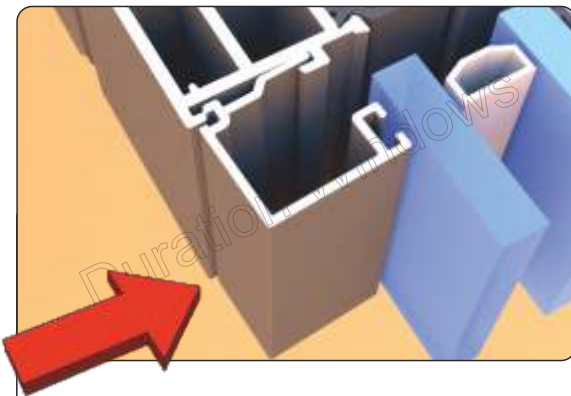

Apply firm and constant pressure on bead face whilst gripping bead.



Bead will successfully click into position. You can then fit wedge gasket (**page 11**).

**DO NOT** Use hammers or similar tools to fit bead.  
Ensure it is done by hand with constant firm pressure.



# Hinges



The holes for the hinges will have been pre-drilled at the factory.

Line up hinges and machine screws with the pre-drilled holes on the back plate.

Insert top and bottom machine screws first.

Line door up level to the top and bottom of the frame.

Check doors are all level.

Finally once door is all level add the final fix self taper screw to the centre of the hinge.

# Wedge Gaskets

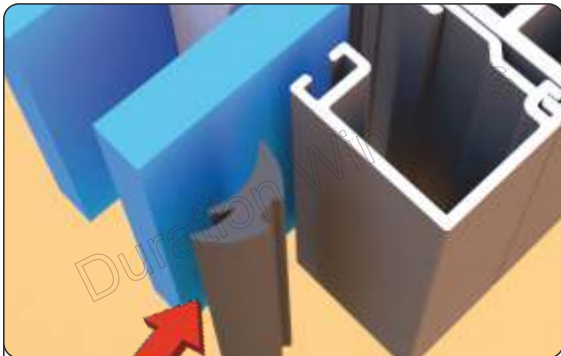

Wedge gaskets are fitted to the internal face of the panel.

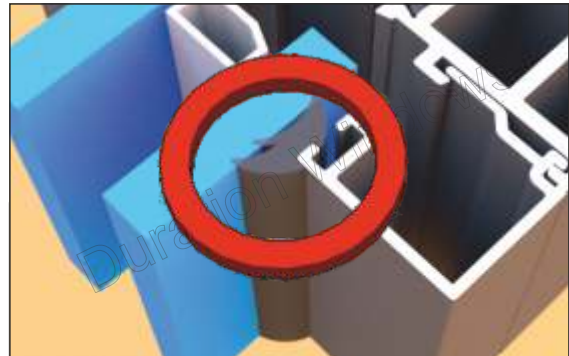

Insert wedge gaskets between the glazed unit and bead.

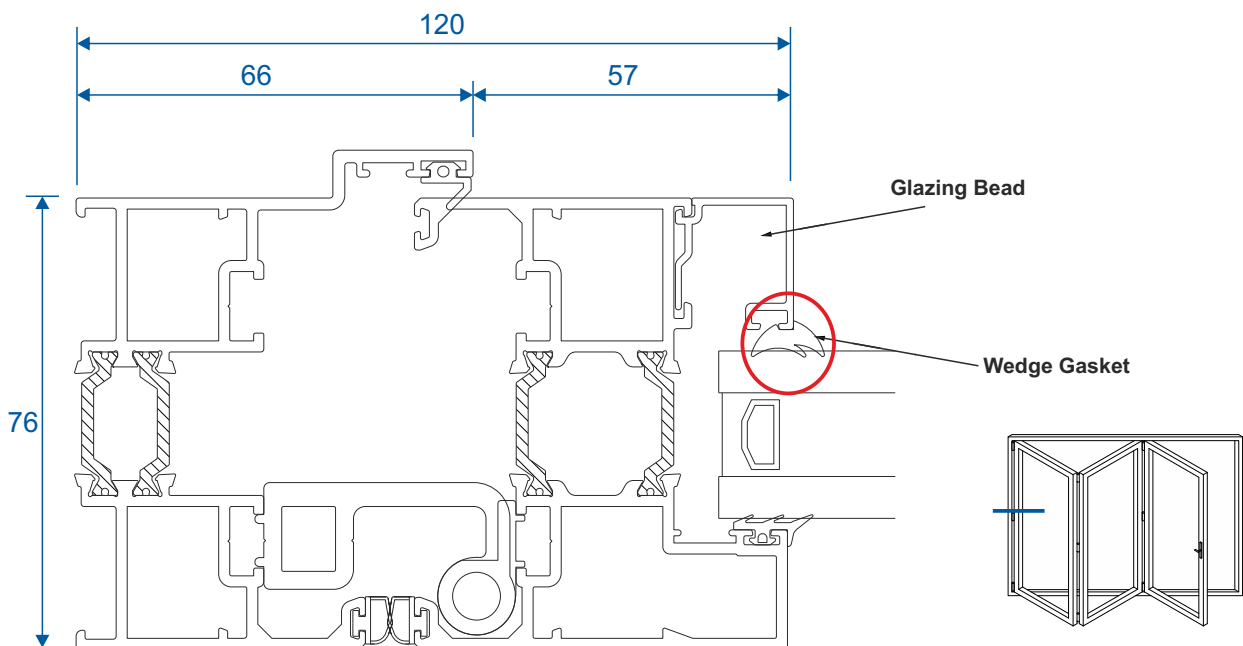

Duration Windows reserve the right to make changes to the product specifications as technical developments dictate, and without prior notice. Pictures shown are for illustrative purposes and are not binding in detail, colour or specification.

# Traffic Door Magnet Retainer

FOR CONFIGURATIONS  
WITH TRAFFIC DOORS



Door retainer magnets will be provided loose if requested.



Screw goes through centre of the magnet.



Slide cover over the magnet and screw.

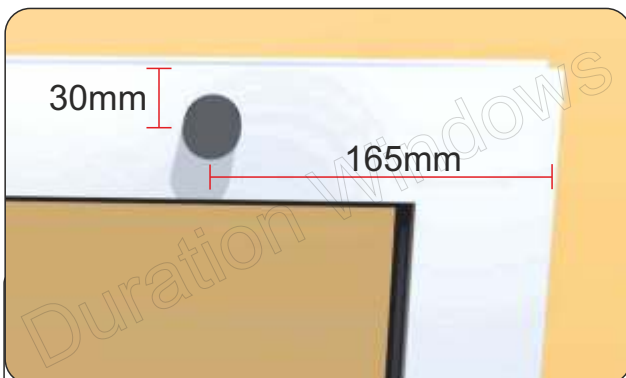

**Traffic Door** magnet position



**Folding Panel** magnet position



## Magnets Function

The magnets are used where traffic or slave doors fold back onto an adjacent panel and are designed to stop the doors and handles colliding with each other.

# Toe & Heeling

**IMPORTANT:** In order for bifolds to operate properly, sealed units must be glazed correctly.



*Example Shown Below  
Viewed from the Inside*

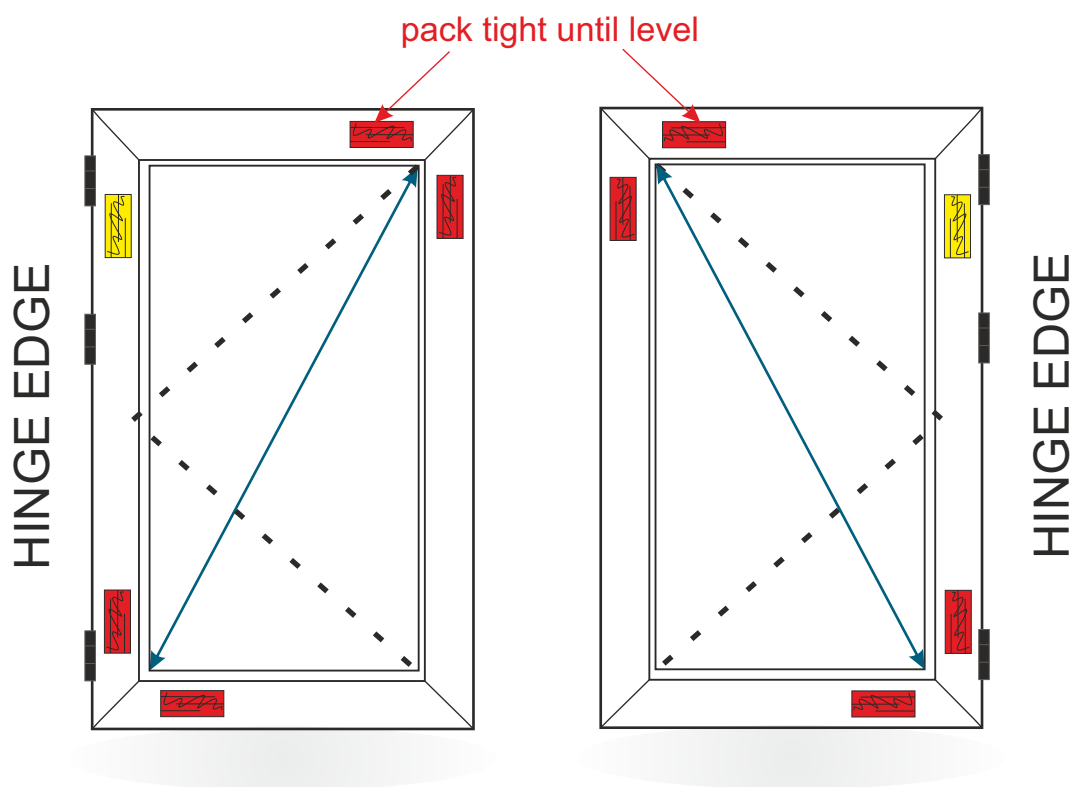

Insert Packers tightly across diagonals, ensure head is level and secure packers in place with silicone.

Internal hinge positions



Packer



Final fix packer

# Toe & Heeling 1,2 and 3 Panels

**IMPORTANT:** All configurations are viewed from the inside.



## 1 Panel

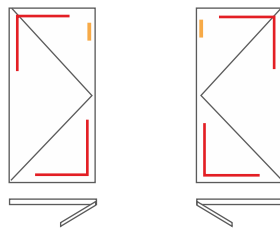

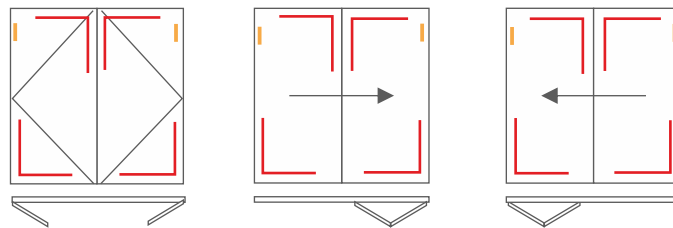

## 2 Panels

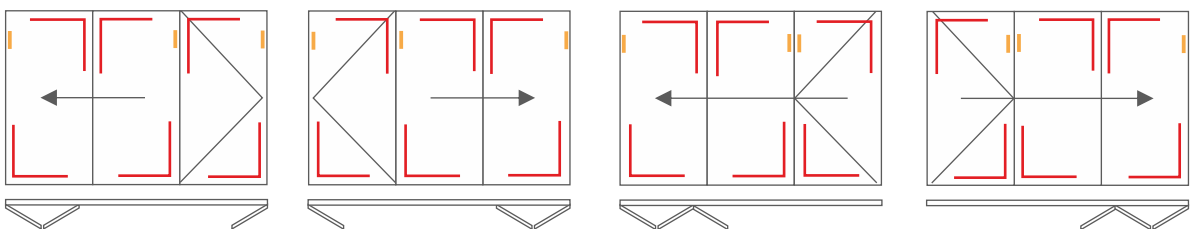

## 3 Panels





 Pack Here  
 Final Fix Packer

# Toe & Heeling 4 Panels

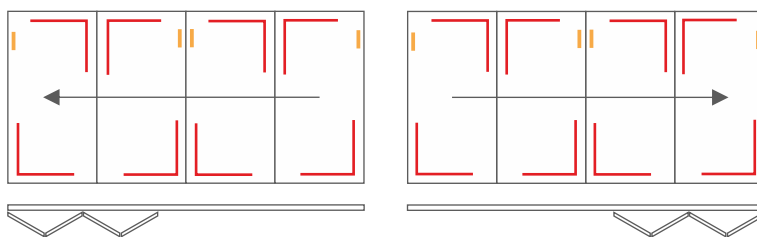
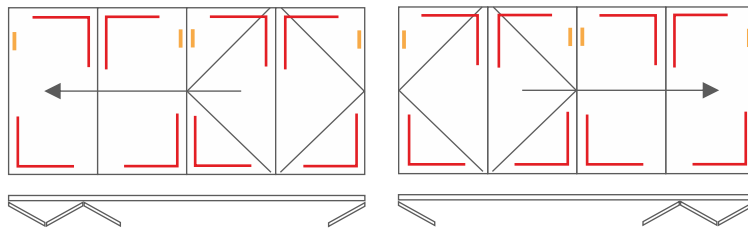
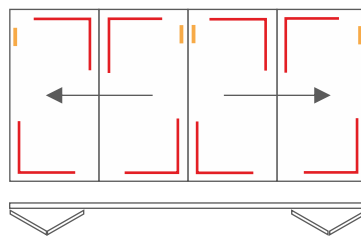
**IMPORTANT:** All configurations are viewed from the inside.



 Pack Here  
 Final Fix Packer

Duration Windows reserve the right to make changes to the product specifications as technical developments dictate, and without prior notice. Pictures shown are for illustrative purposes and are not binding in detail, colour or specification.

# Toe & Heeling 5 Panels

**IMPORTANT:** All configurations are viewed from the inside.

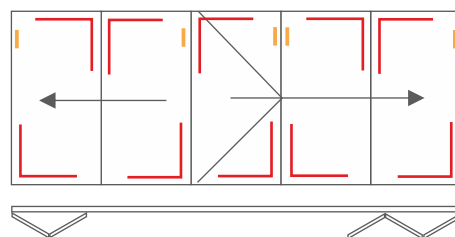
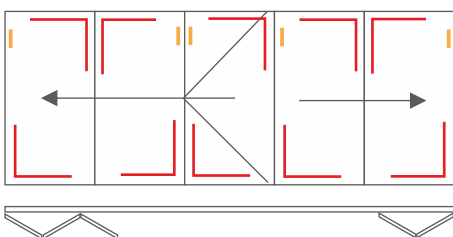
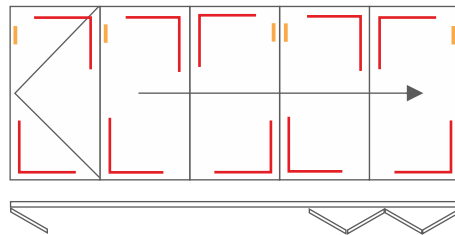
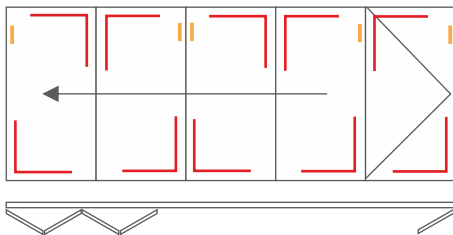
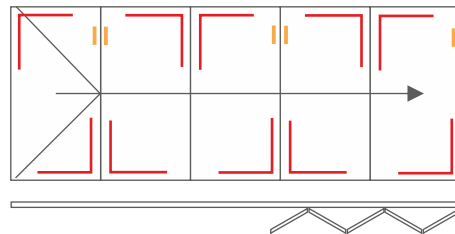
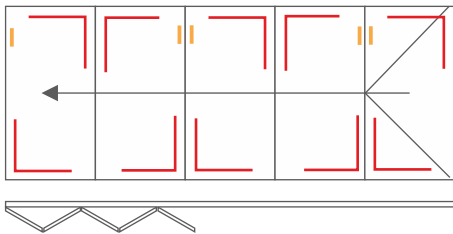

 Pack Here



 Final Fix Packer

Duration Windows reserve the right to make changes to the product specifications as technical developments dictate, and without prior notice. Pictures shown are for illustrative purposes and are not binding in detail, colour or specification.

# Toe & Heeling 6 Panels

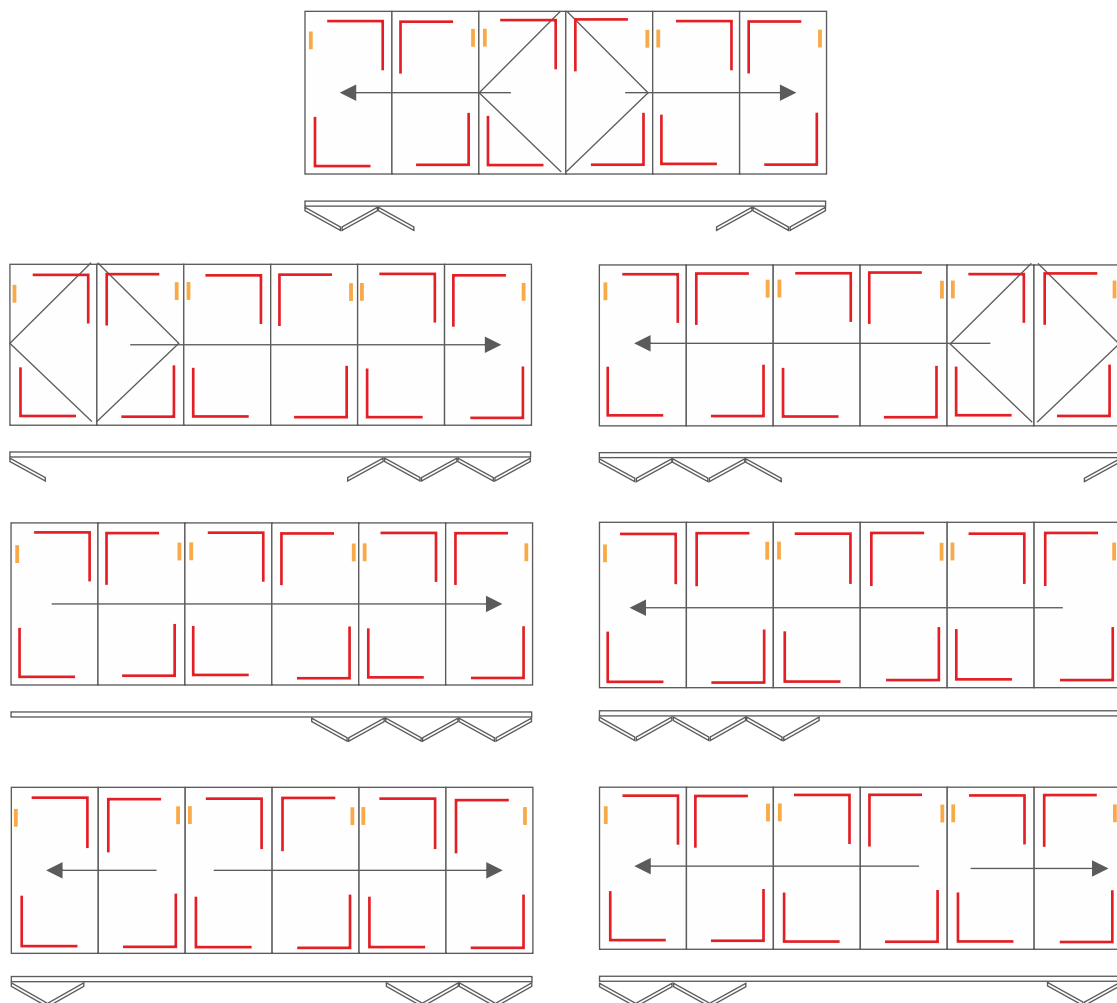
**IMPORTANT:** All configurations are viewed from the inside.



 Pack Here  
 Final Fix Packer



Duration Windows reserve the right to make changes to the product specifications as technical developments dictate, and without prior notice. Pictures shown are for illustrative purposes and are not binding in detail, colour or specification.

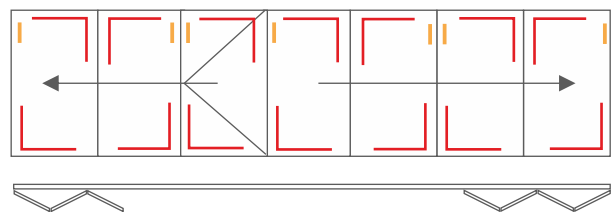
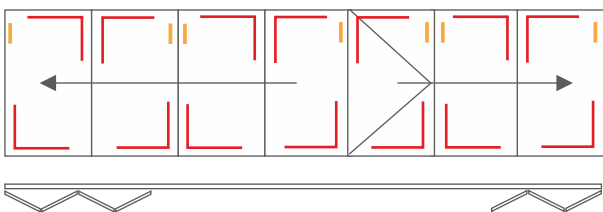
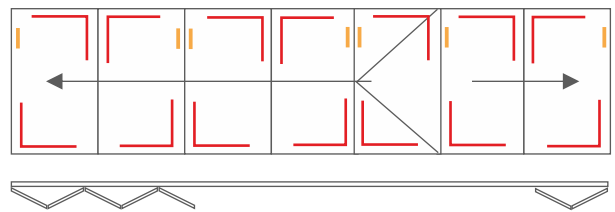
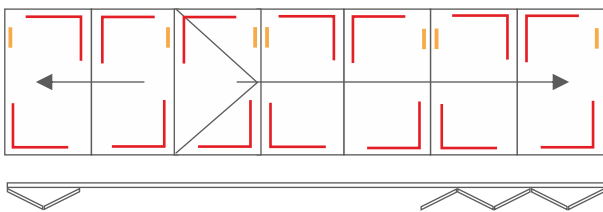
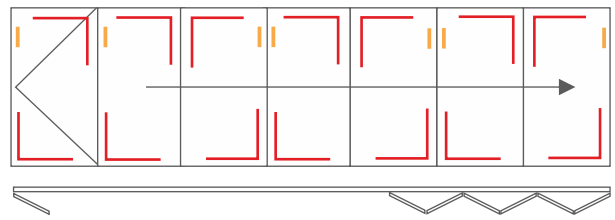
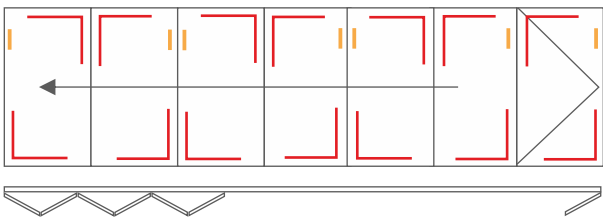
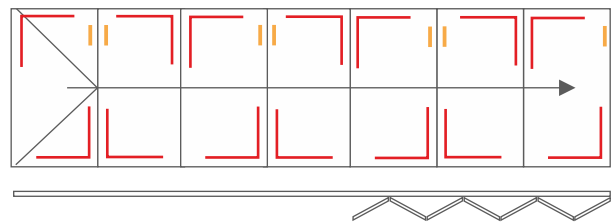
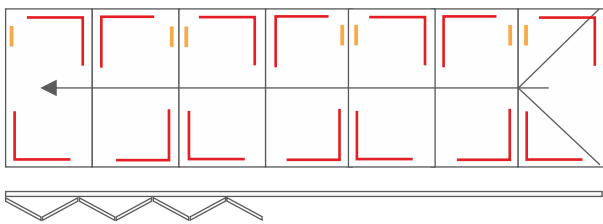

# Toe & Heeling 7 Panels

**IMPORTANT:** All configurations are viewed from the inside.



 Pack Here  
 Final Fix Packer

Duration Windows reserve the right to make changes to the product specifications as technical developments dictate, and without prior notice. Pictures shown are for illustrative purposes and are not binding in detail, colour or specification.

# Toe & Heeling Process

**This is intended only as a guide.**

All doors are unique and may require different packing levels.

If you are unsure please contact a professional.

An example 3 panel configuration (folding all one way) is shown right.

Red sections display where to toe and heel

Yellow sections display the final fix packer position.

Toe and heel panel attached to the frame first and work towards the traffic / slave door.



Packers are supplied in a range of sizes, colour coded for ease of use. Packers used in this guide are an example only.

Each door is unique and will require different levels of packing. Always use a range of packers to best suit the door being toe and heeled.

Where required, use a toe and heeling glazing shovel.



# Toe & Heeling Process

**This is intended only as a guide.**

All doors are unique and may require different packing levels.

If you are unsure please contact a professional.

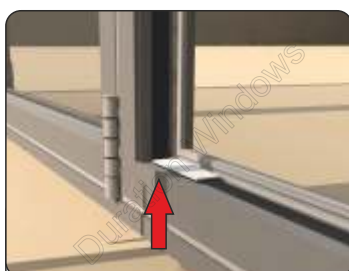

Place 2-3 packers at the bottom of the door on the hinge side.

Number of packers depends on door tolerances.



Place glazed unit into door frame.



Pack the top of the unit on the handle side of the door.

Use a variety of packers until the glazed unit sits firm in place.



Pack the side of the unit on the handle side of the door. Use a variety of packers until the glazed unit sits firm in place and square within the frame.



Pack the side of the unit on the hinge side of the door. Use a variety of packers until glazed unit sits firm in place and square within the frame.



Lastly pack the top side corner on the hinge side of the door. Use a variety of packers until the glazed unit sits firm in place. This will help keep the glazed unit square and in place.

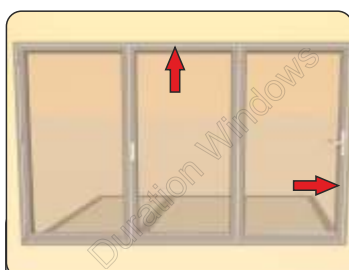

Check door is completely level with the outer frame. If not add or remove packers where needed.

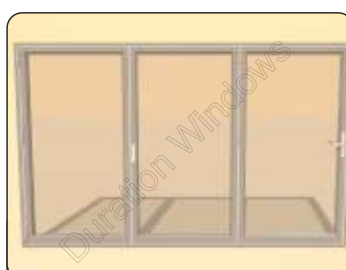

Once all panels have been toe and heeled check door is running correctly and that the locking system works correctly.

If required silicone the packers on the uprights of the door into place. (this will prevent the packers from moving).

Finally clip bead into place.

Duration Windows  
Thames Development  
Charfleets Road  
Canvey Island  
Essex. SS8 0PQ

[sales@duration.co.uk](mailto:sales@duration.co.uk)  
[www.duration.co.uk](http://www.duration.co.uk)

**Head Office** 01268 681612  
**Showroom** 01268 695100