



## Continental Folding Doors Thresholds, Floor Levels & Drainage

### Contents

● Overview	Page 2
● Standard Threshold - Open Out	Page 3
● Standard Threshold - Open In	Page 4
● Standard Threshold On Cill - Open Out	Page 5
● Standard Threshold On Cill - Open In	Page 6
● Low Threshold - Open Out	Page 7
● Low Threshold - Open In	Page 8
● Low Threshold On Cill - Open Out	Page 9
● Low Threshold On Cill - Open In	Page 10
● Ramped Threshold - Open Out	Page 11
● Ramped Threshold - Open In	Page 12
● Threshold Drainage Paths	Page 13-14

**Please Note:** The sizes provided in this document need to be taken into account and included in the manufacture sizes you provide.



Floor Levels Overview - Threshold Options

Standard Threshold - Open Out

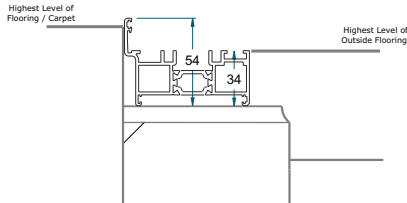

Standard Threshold - Open In

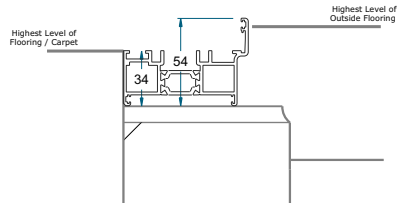

Standard Threshold on Cill - Open Out

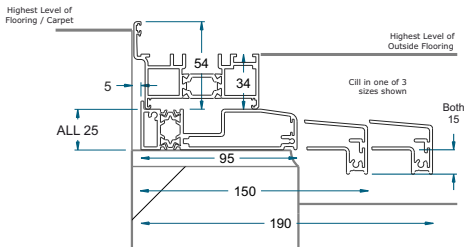

Standard Threshold on Cill - Open In

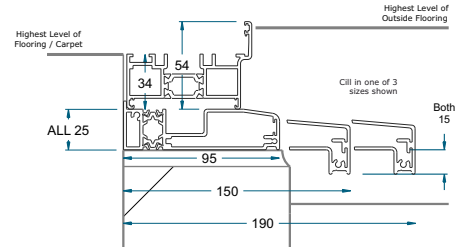

Low Threshold - Open Out

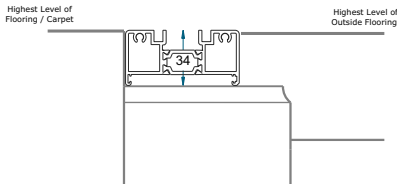

Low Threshold - Open In

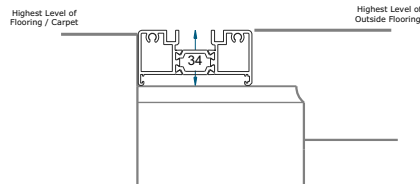

Low Threshold on Cill - Open Out

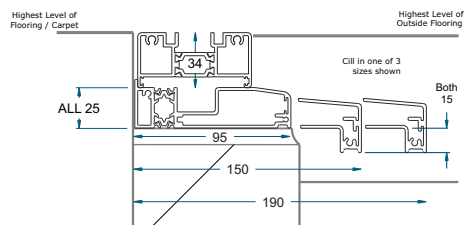

Low Threshold on Cill - Open In

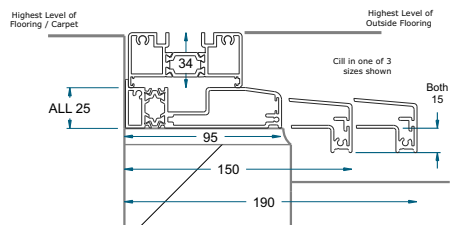

Ramped Threshold - Open Out

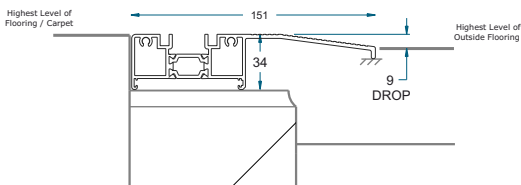

Ramped Threshold - Open In

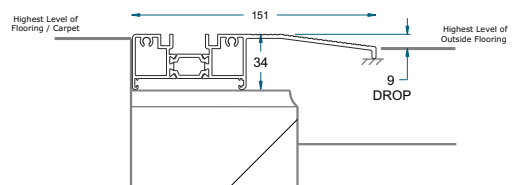

Please Note: Intended For Guidance Only - Not An Installation Drawing Or A Builder's Work Instruction

**Standard Threshold - Open Out**

Highest Level of  
Flooring / Carpet

Highest Level of  
Outside Flooring

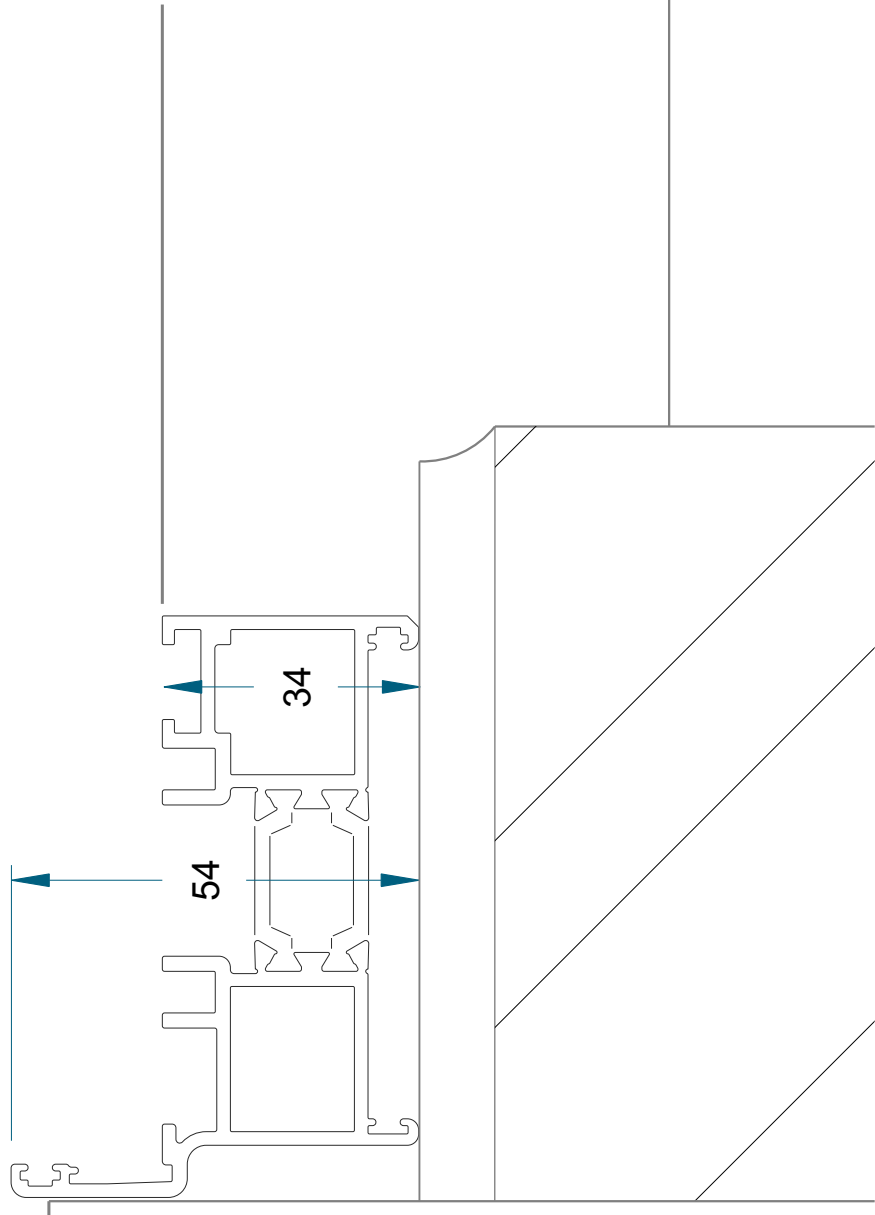

Artistic Representation



**Standard Threshold - Open In**

Highest Level of  
Flooring / Carpet

Highest Level of  
Outside Flooring

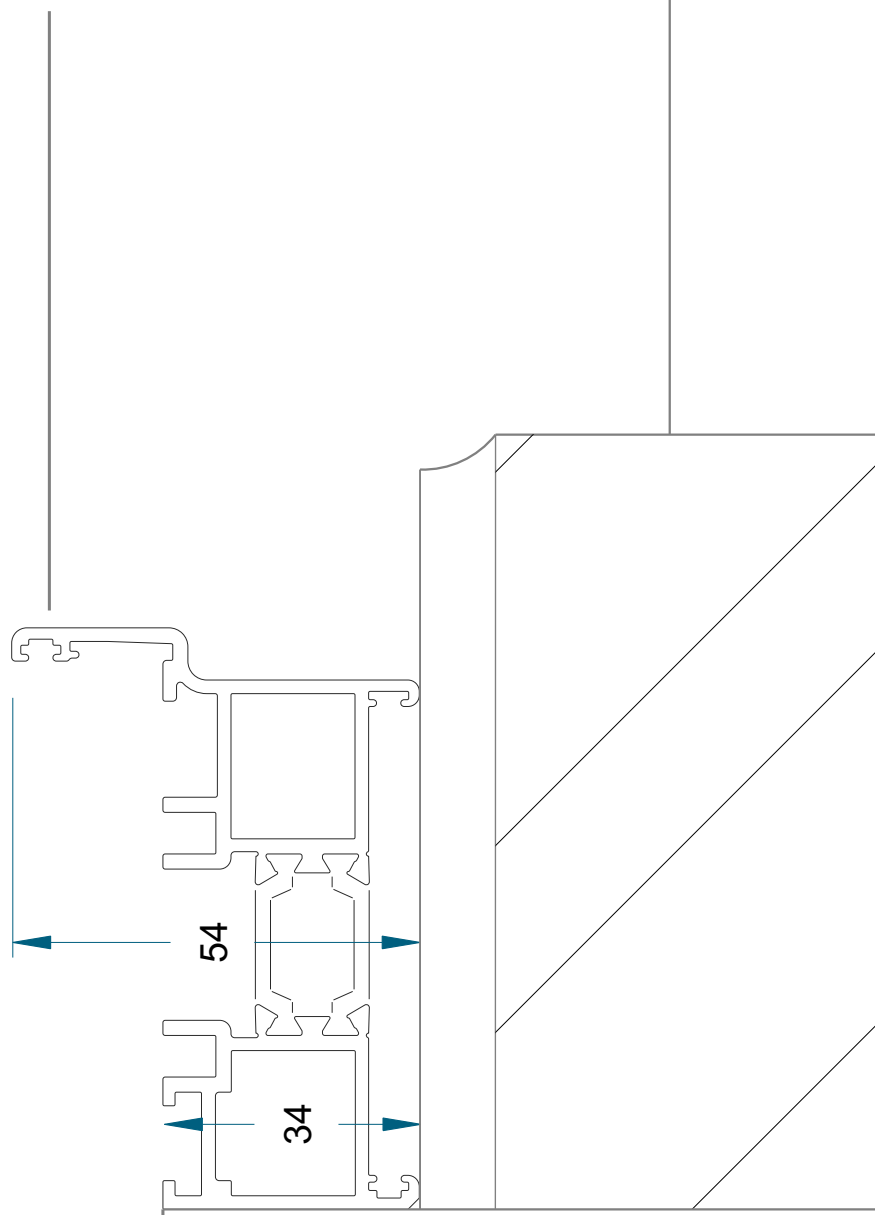

Artistic Representation

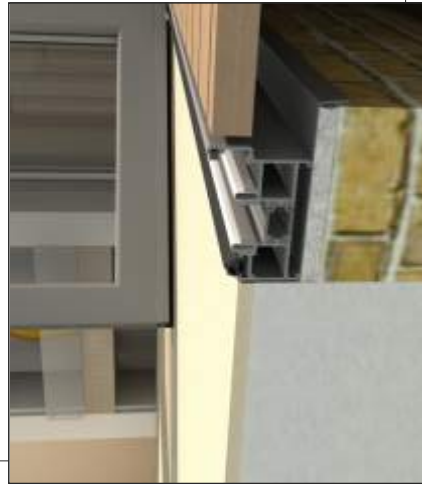

**Std Threshold On Cill - Open Out**

Highest Level of  
Flooring / Carpet

Highest Level  
of Outside Flooring

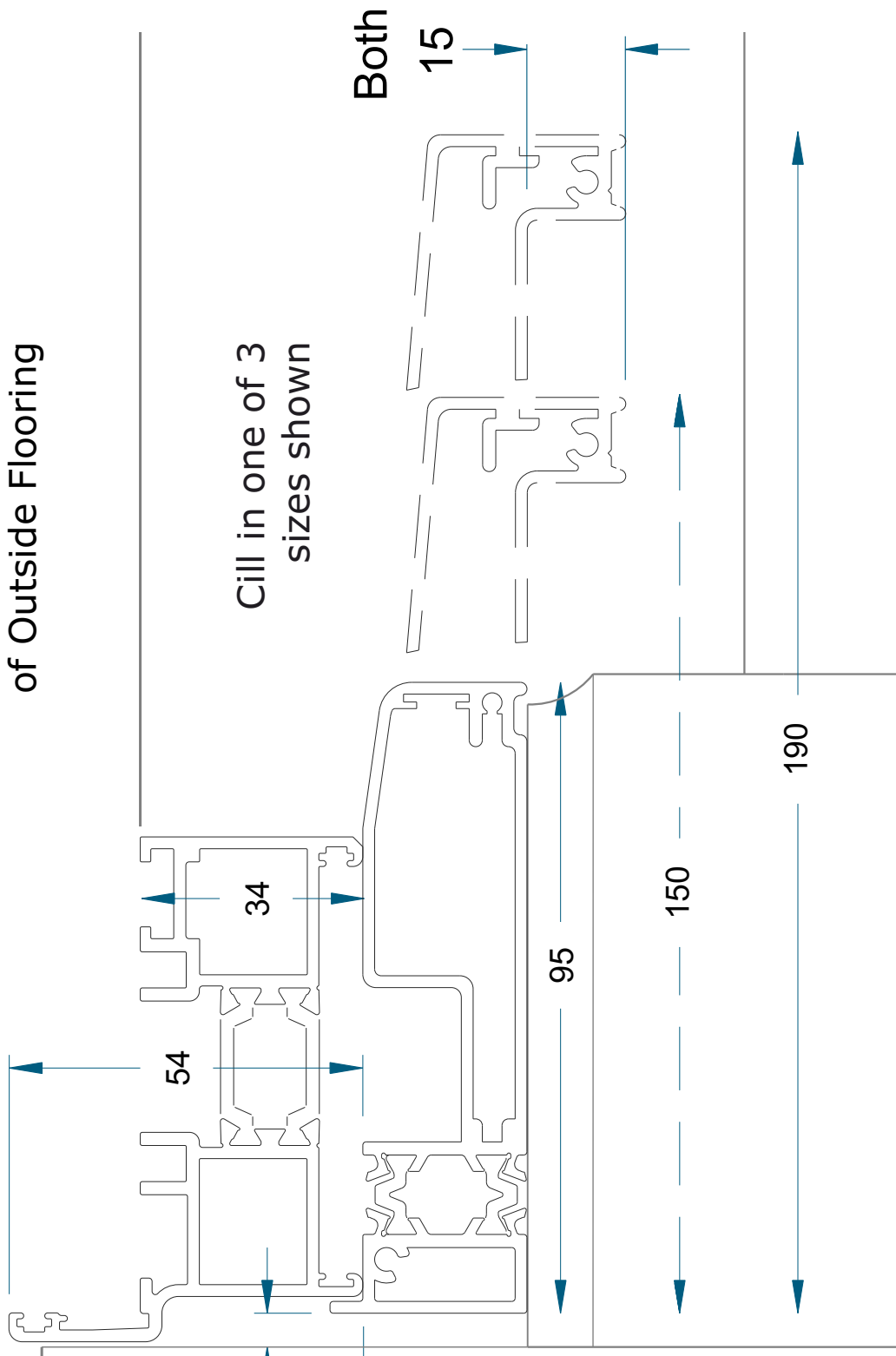

5

54

34

95

150

190

ALL 25

Both

15

Cill in one of 3  
sizes shown

Artistic Representation - 150 Cill Shown



**Std Threshold On Cill - Open In**

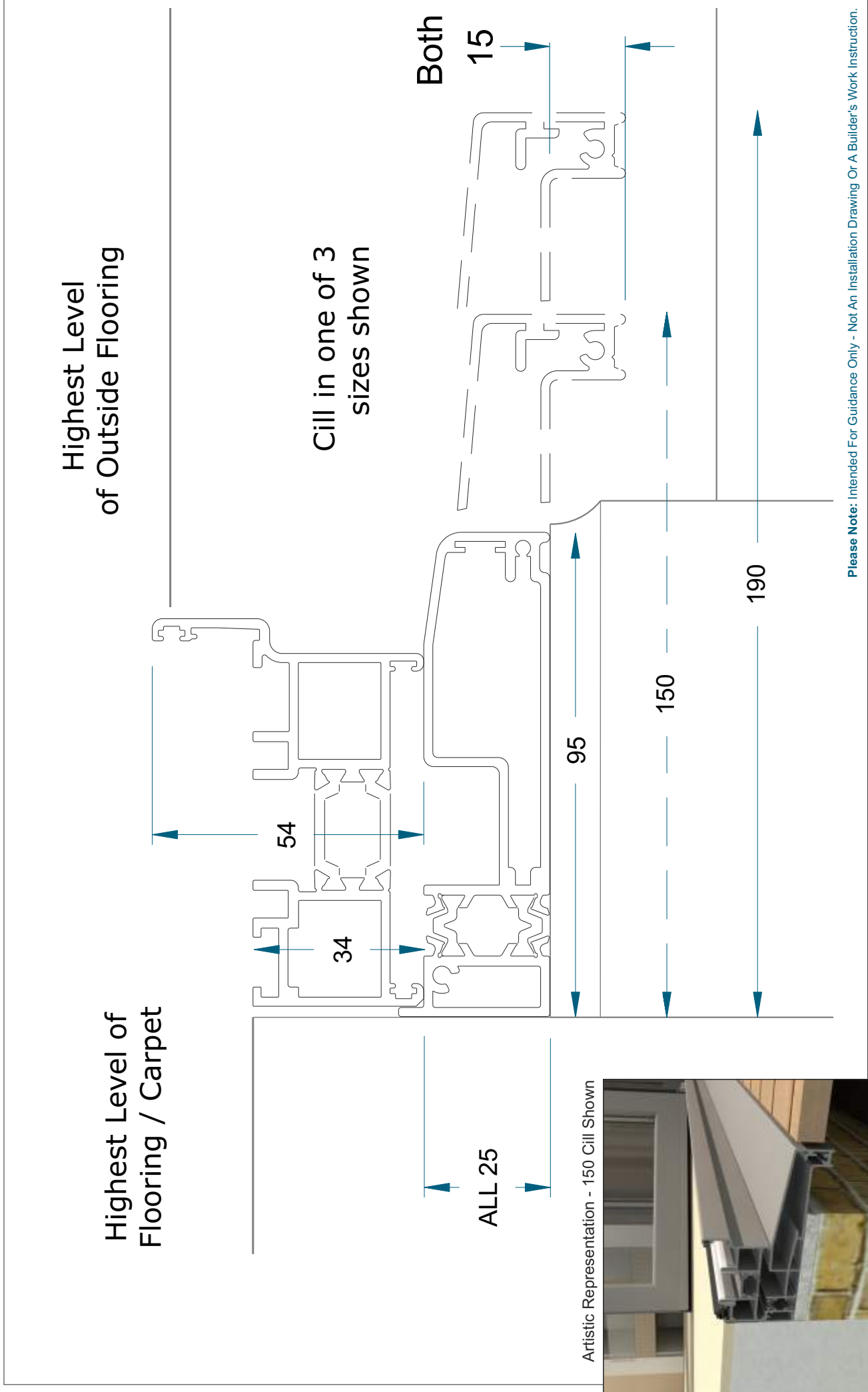

Please Note: Intended For Guidance Only - Not An Installation Drawing Or A Builder's Work Instruction.

Low Threshold - Open Out

Highest Level of  
Flooring / Carpet

Highest Level of  
Outside Flooring

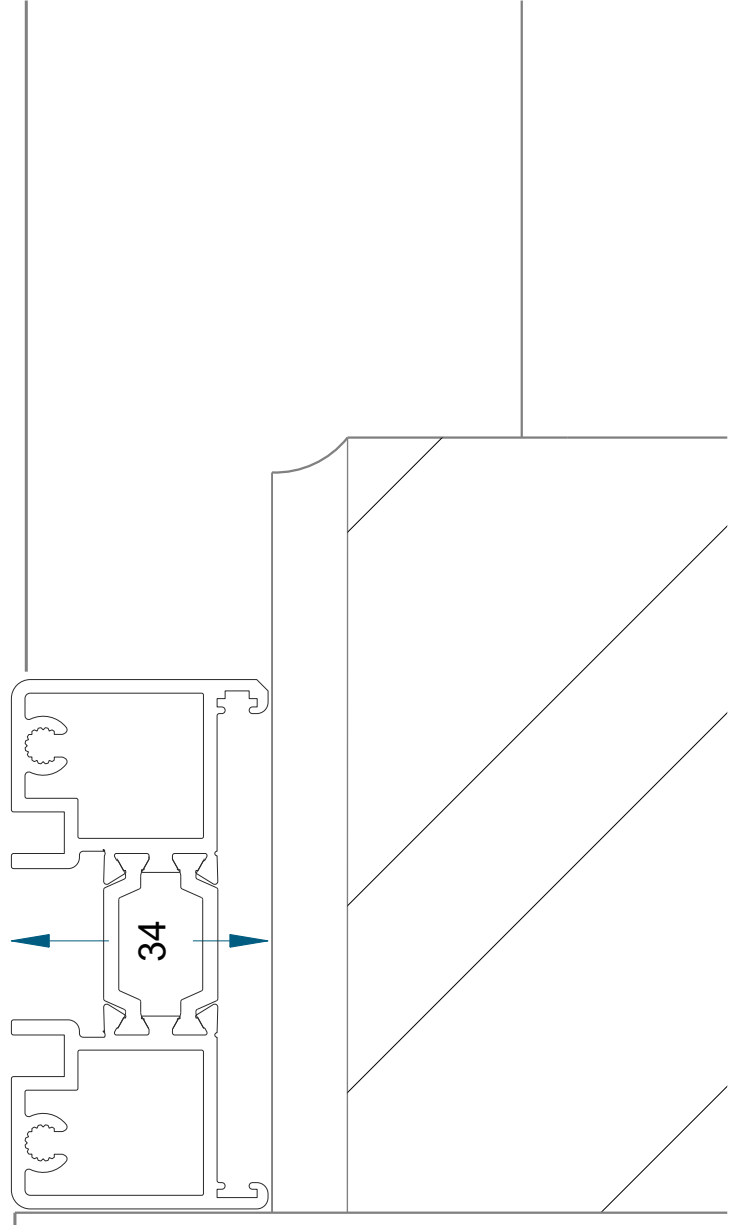

Artistic Representation



Low Threshold - Open In

Highest Level of  
Flooring / Carpet

Highest Level of  
Outside Flooring

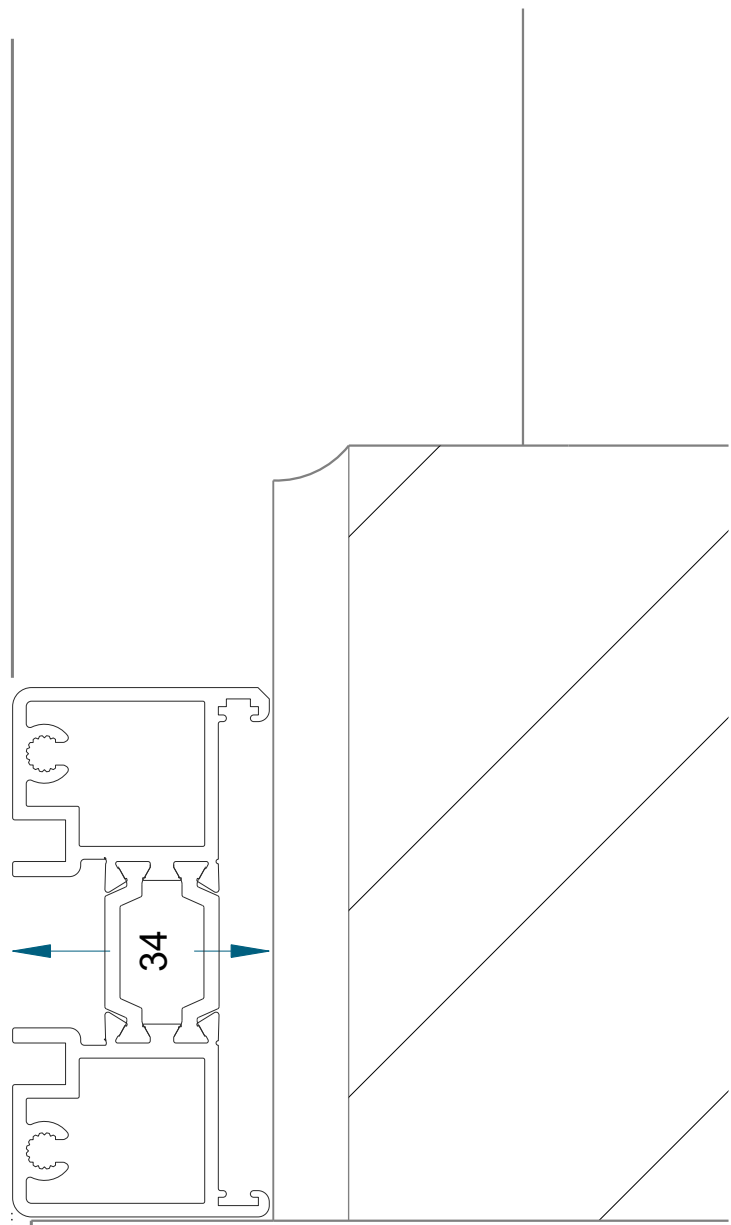

Artistic Representation





Low Threshold On Cill - Open Out

Highest Level of Flooring / Carpet

Highest Level of Outside Flooring

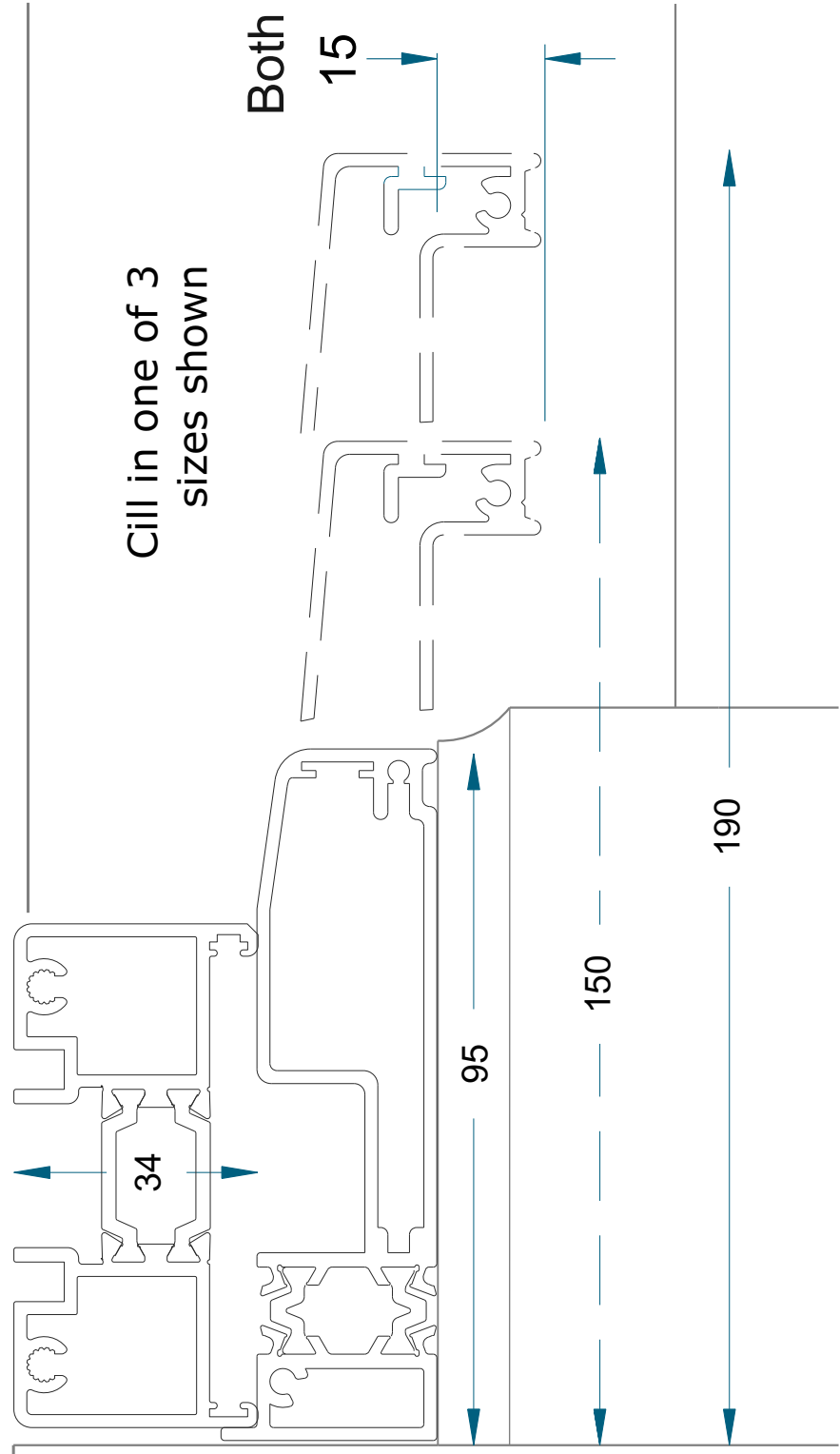

Artistic Representation - 150 Cill Shown



Low Threshold On Cill - Open In

Highest Level of  
Flooring / Carpet

Highest Level of  
Outside Flooring

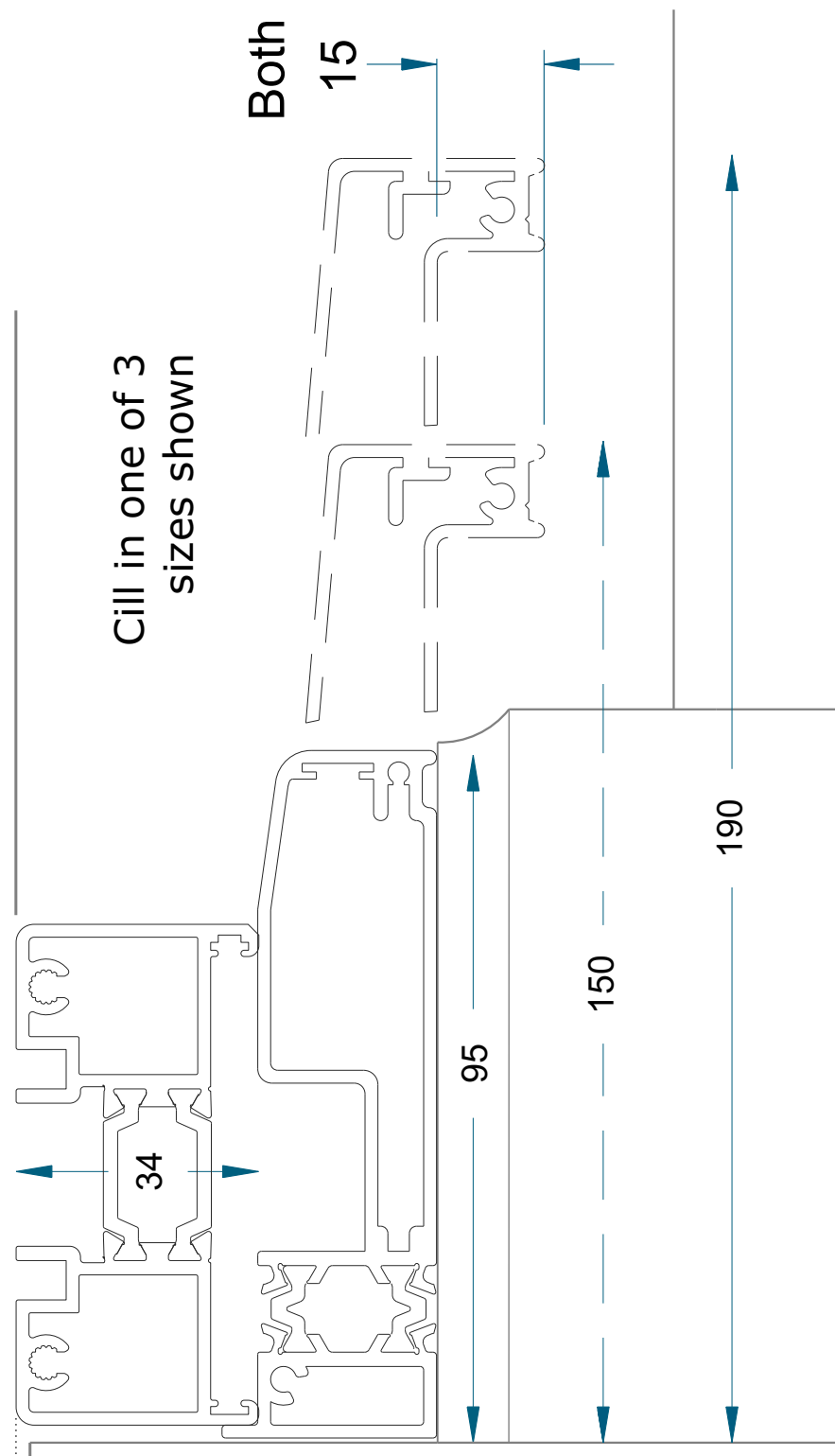

Artistic Representation - 150 Cill Shown



Please Note: Intended For Guidance Only - Not An Installation Drawing Or A Builder's Work Instruction.

Ramped Low Threshold - Open Out

Highest Level of  
Flooring / Carpet

Highest Level of  
Outside Flooring

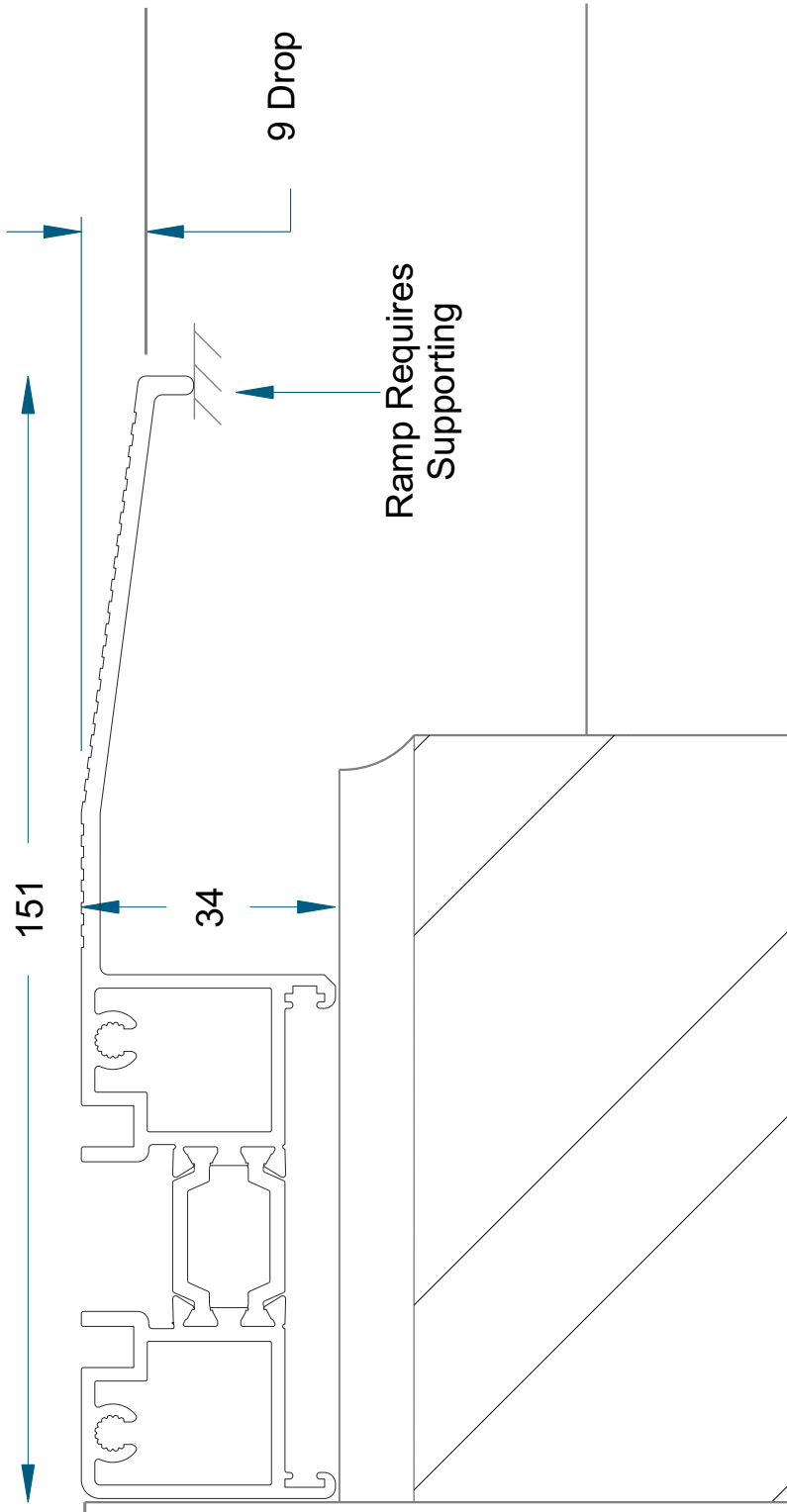

Artistic Representation



Ramped Low Threshold - Open In

Highest Level of  
Flooring / Carpet

Highest Level of  
Outside Flooring

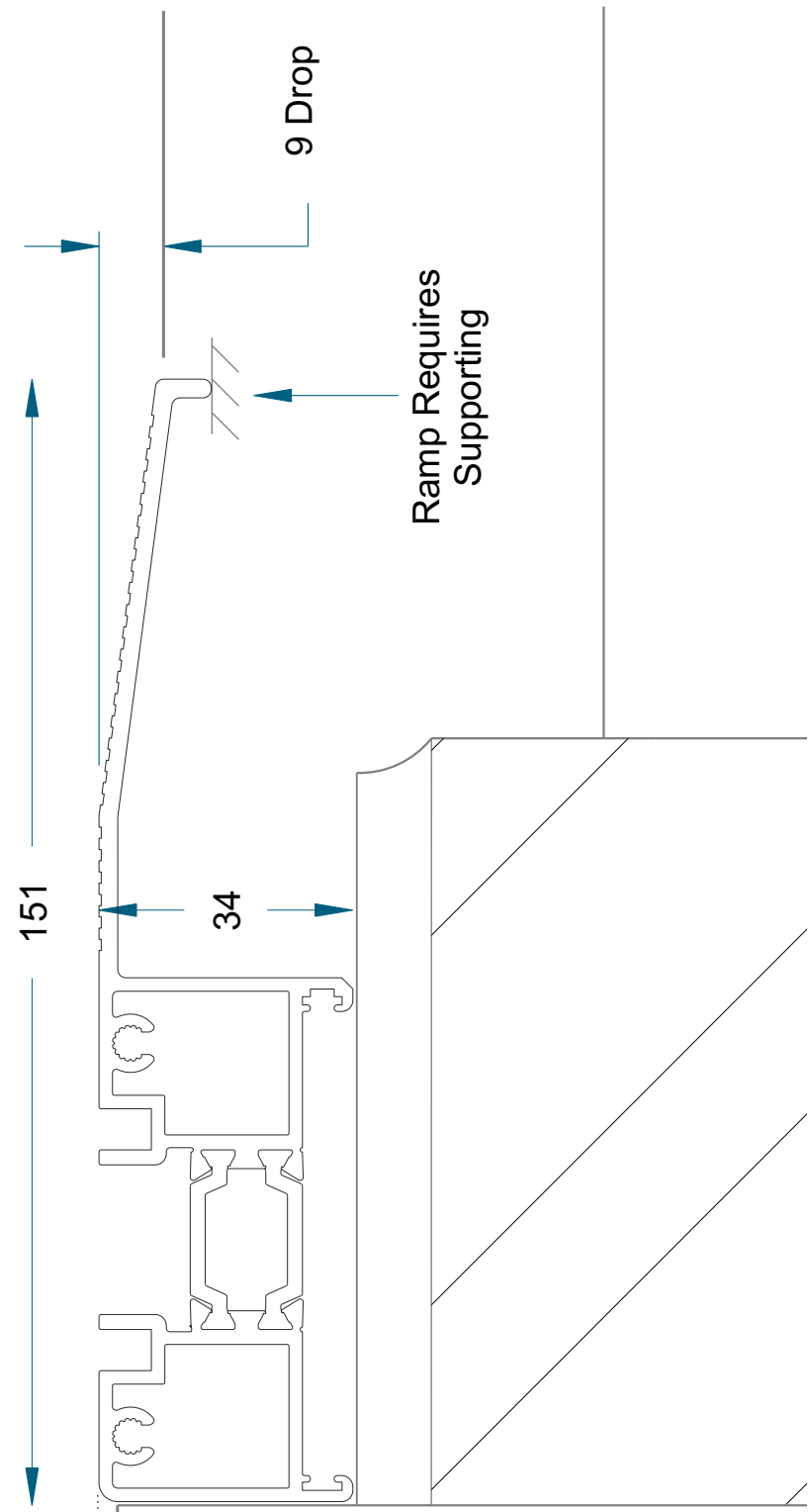

Artistic Representation





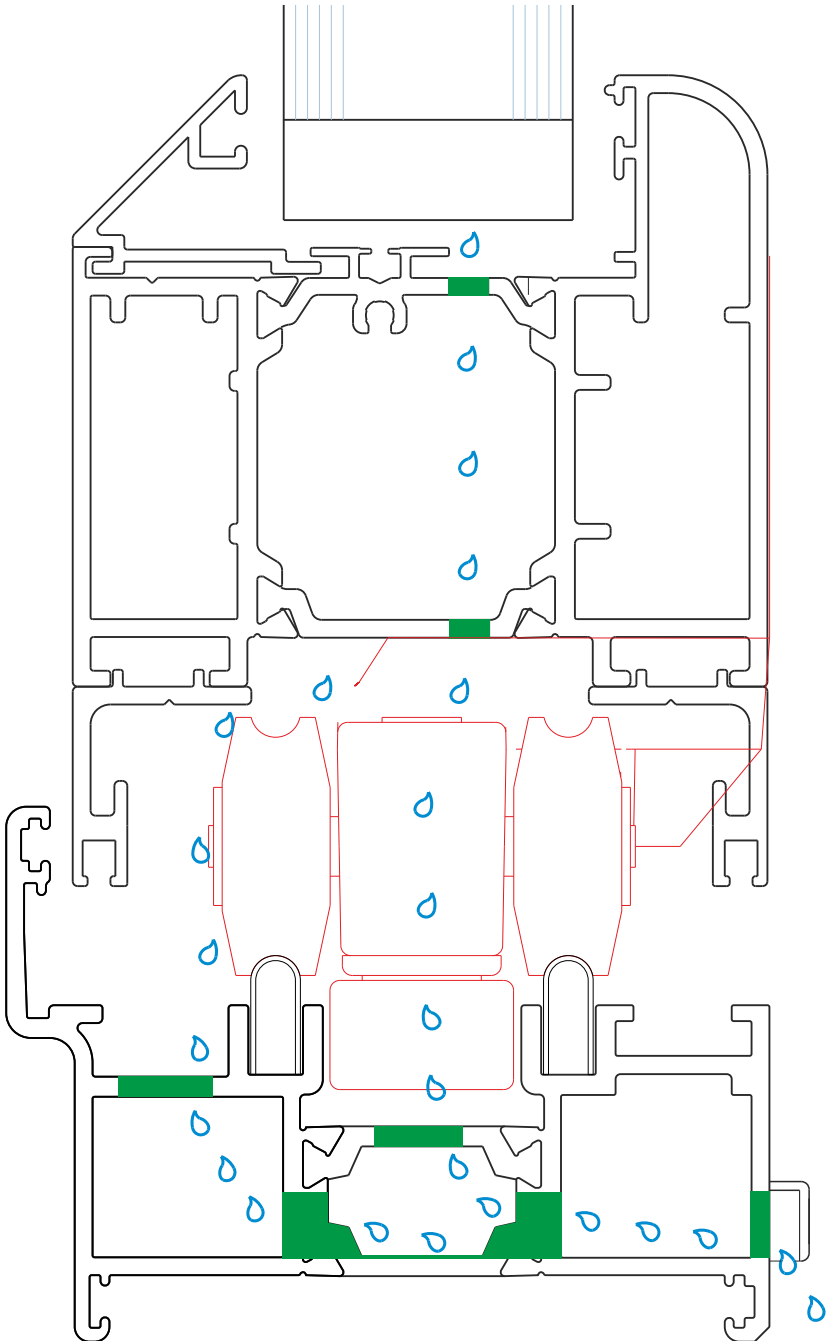

Drainage Paths



**Key / Legend**

-  Drainage Holes
-  Water Droplet



Drainage Paths

Low Threshold

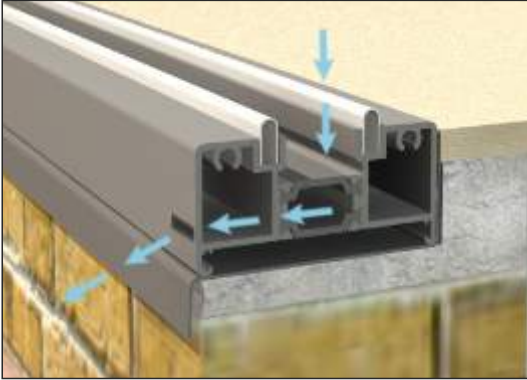

Low Threshold With Cill

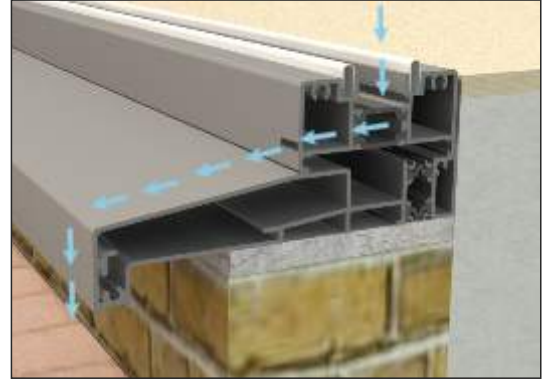

Standard Threshold (Open Out)

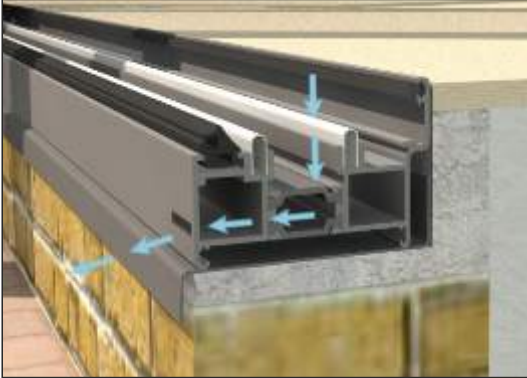

Standard Threshold With Cill (Open Out)



Standard Threshold (Open In)

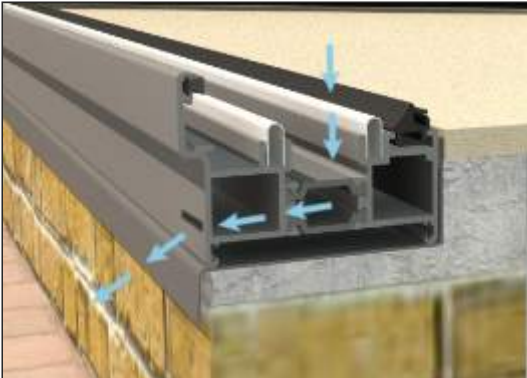

Standard Threshold With Cill (Open In)

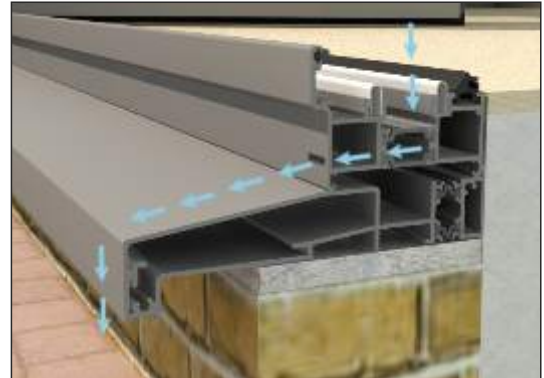

Duration Threshold (With Ramp)

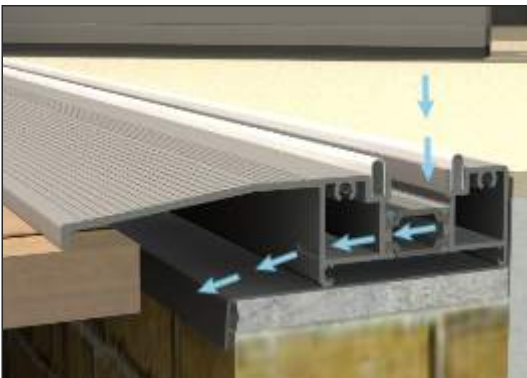

When installing your bifold door and external flooring please take drainage paths into consideration.

Please Note: Drainage caps are not shown.

Key / Legend

