

Royale VS Sash

Section Identification Guide

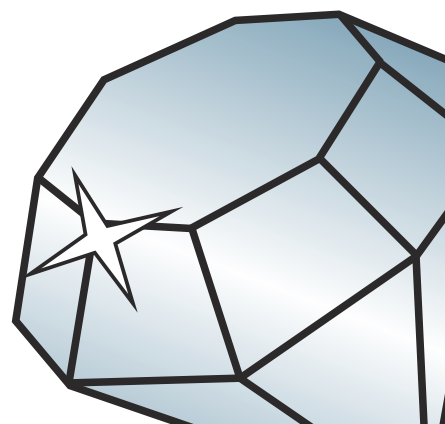

DURATION
WINDOWS



Contents



Head & Jamb	3
Cill	4
Sashes	5
Beads, Interlock & Astragals	6

Sections

Head, Interlock / Midrail, Cill	7
Jamb	8
Astragal	9

Head & Jamb

VS111 - Head Frame

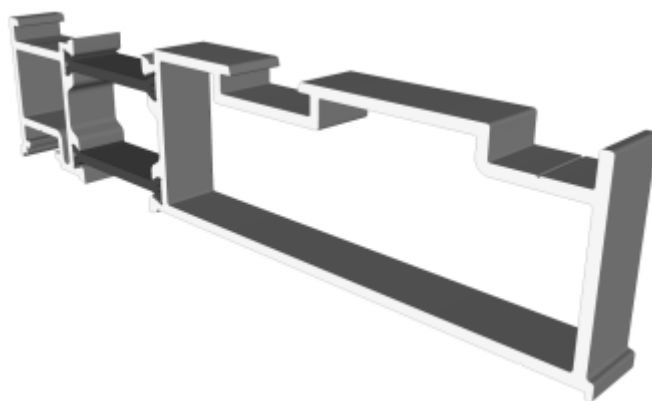
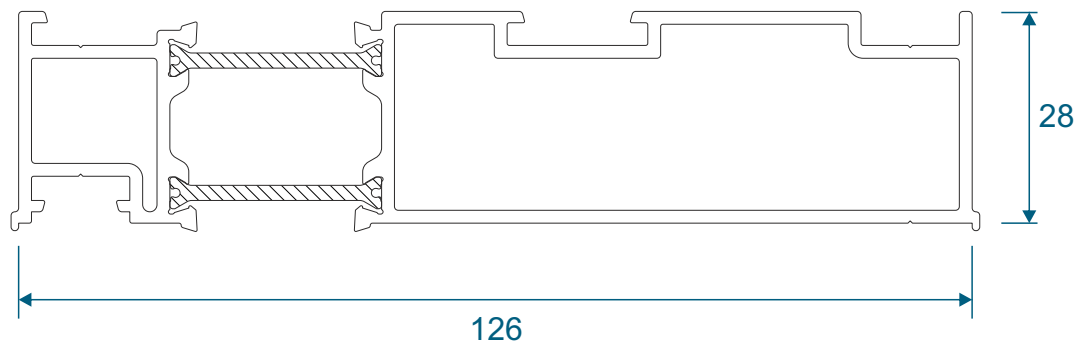

VS112 - Jamb

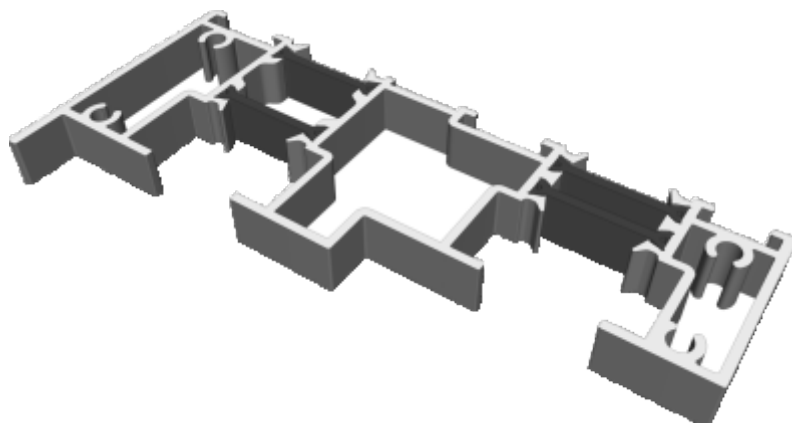
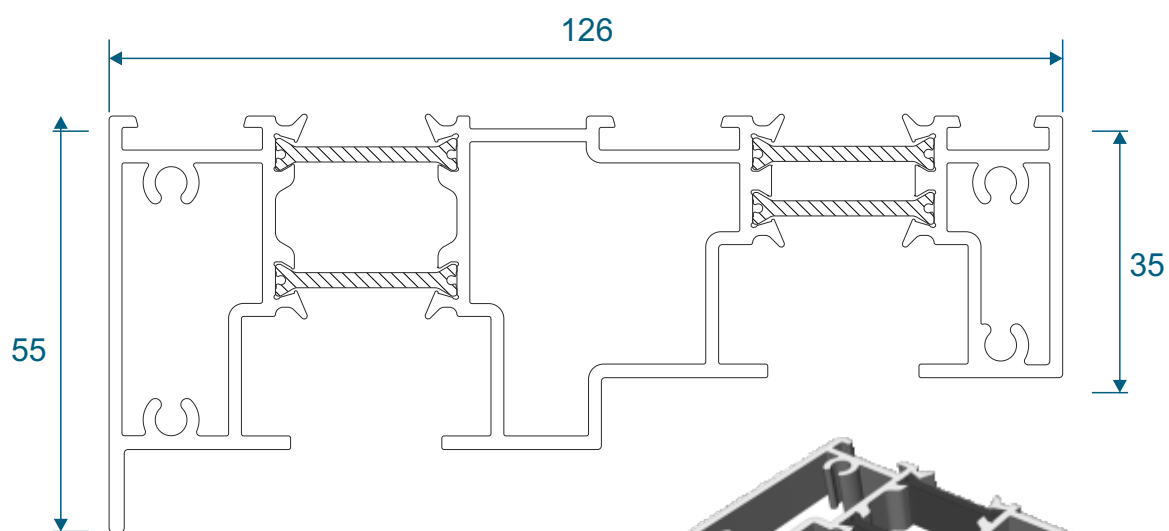

Cill

ZSB147 - Cill

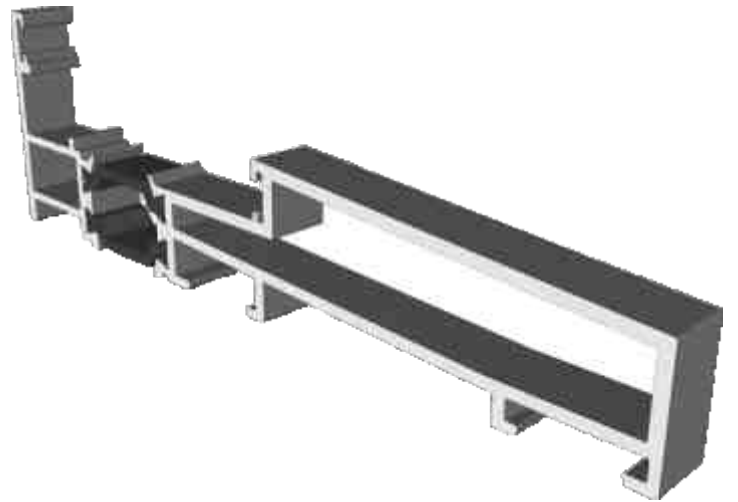
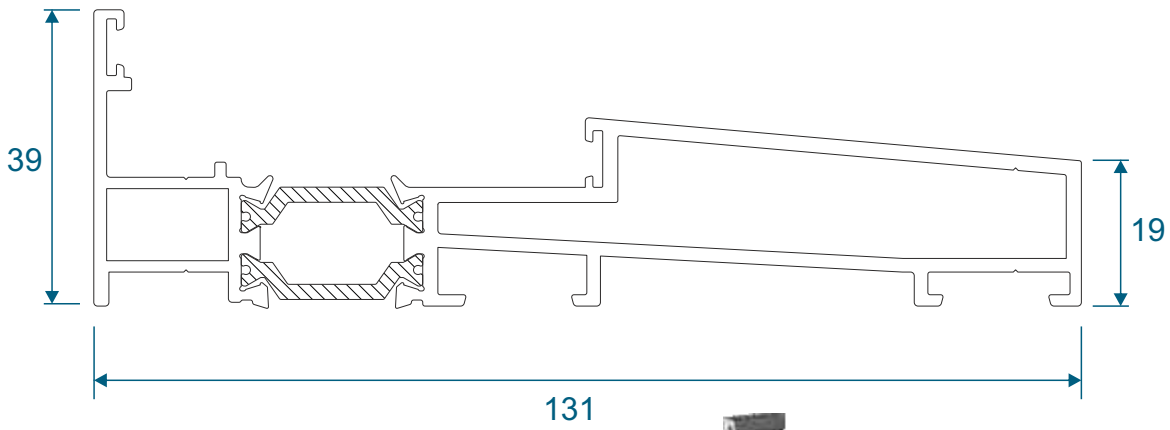

ETC458 - Optional 190mm Cill For Extra 57mm Projection

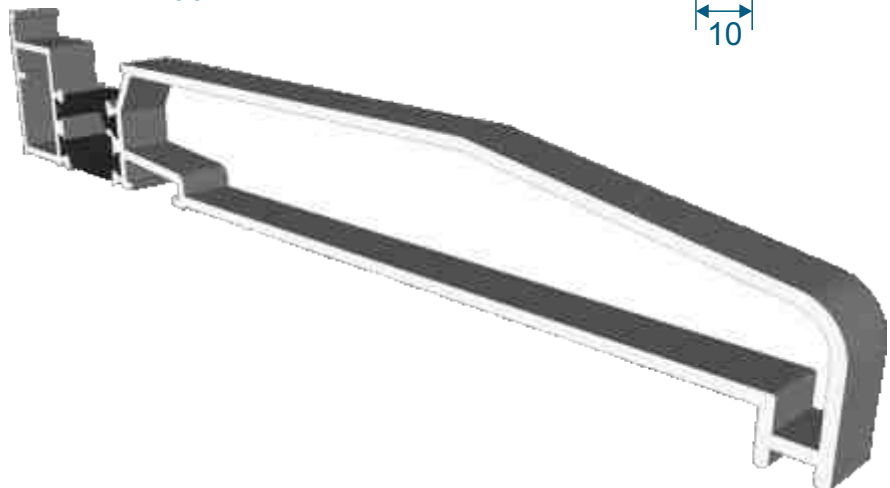
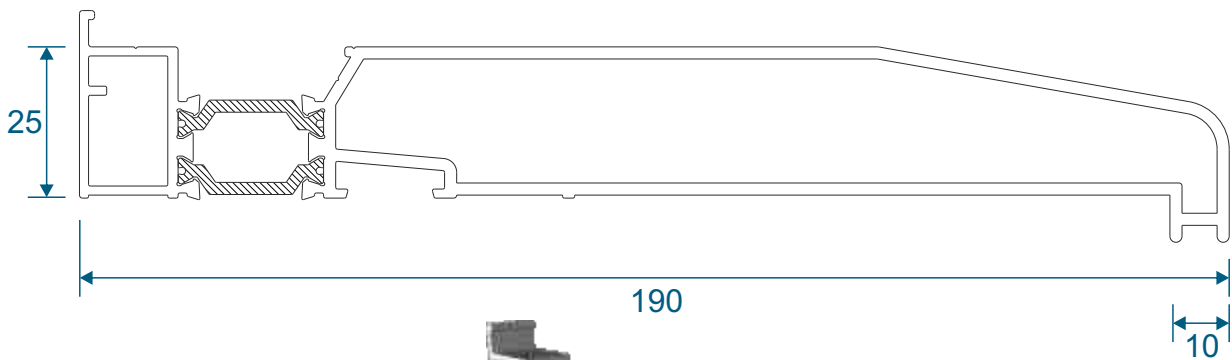

Sashes

ZSB144 - Top Rail Of Top Sash

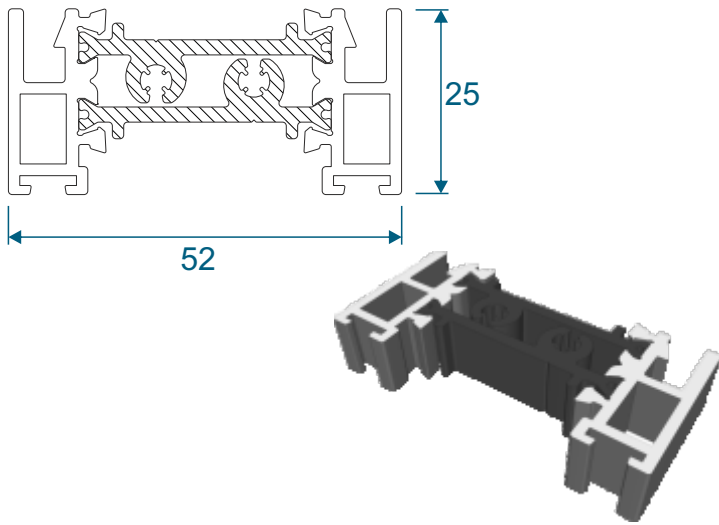

ZSB145 - Top & Bottom Rail Of Transom

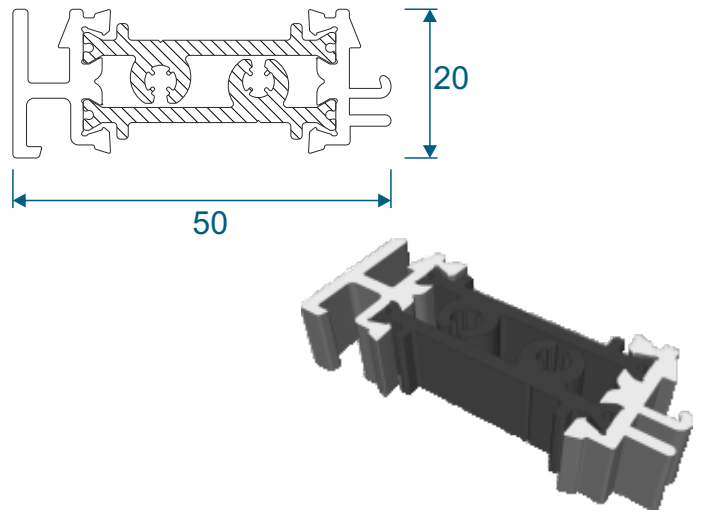

ZSB123 - Jamb Of Bottom Sash

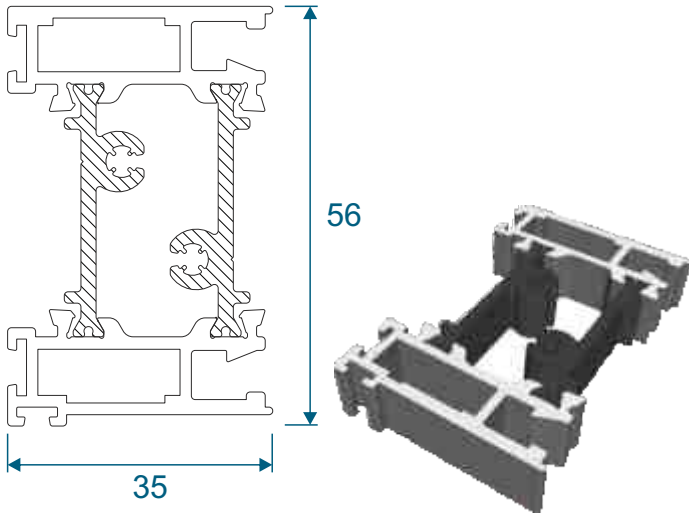

ZSB124 - Jamb Of Top Sash

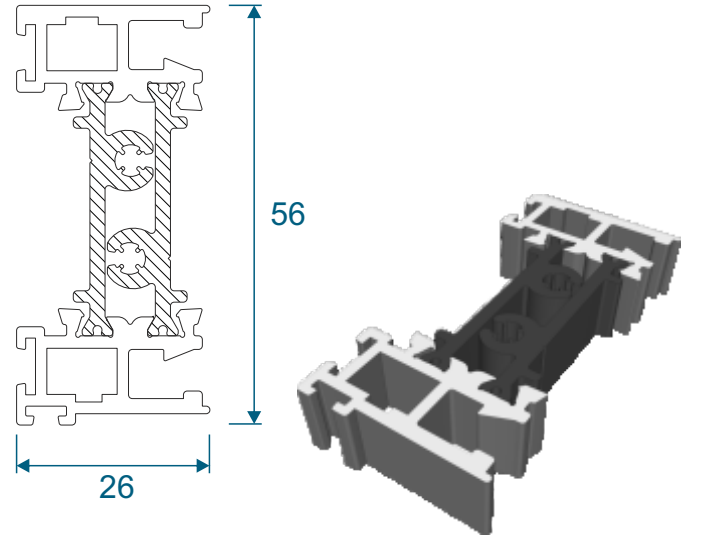

ZSB146 - Deep Bottom Rail

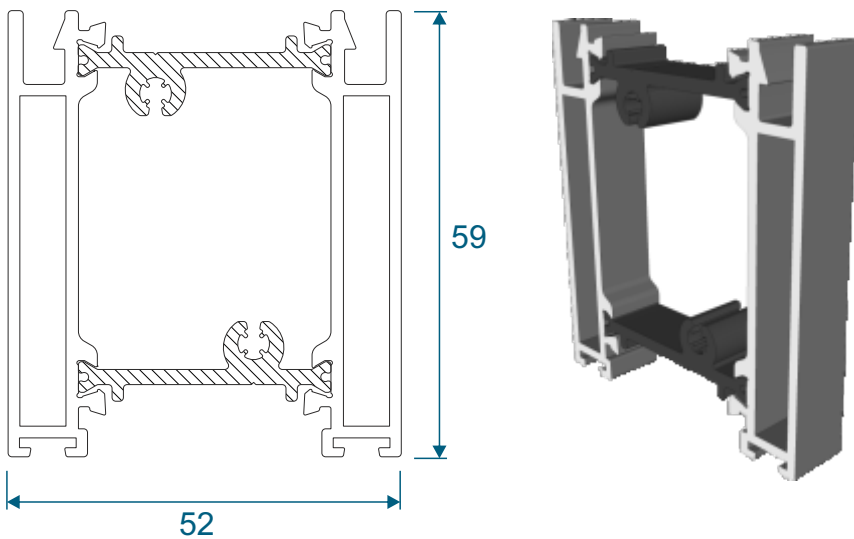

Beads, Interlocks & Astragal

ZSB148 - Horizontal Chamfered Bead

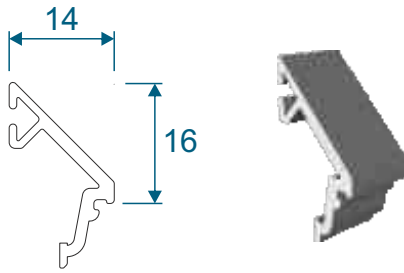

ZSB154 - Vertical Chamfered Bead

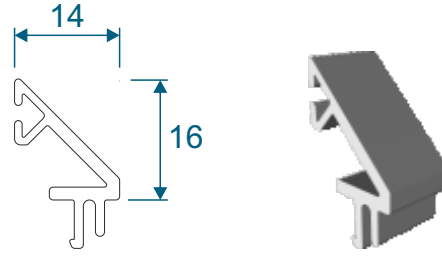

VS045 - Internal Square Bead

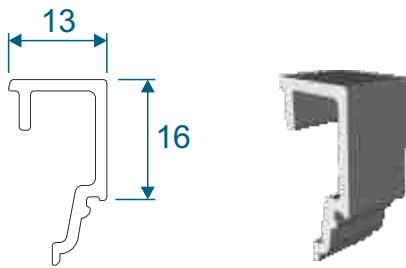

VS130 - Interlock Cap

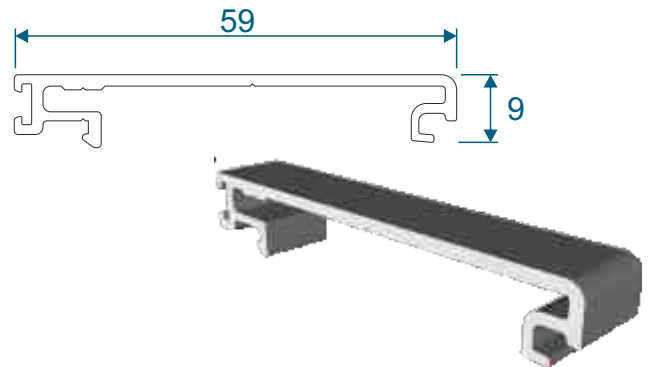

VS031 - External PVC Interlock

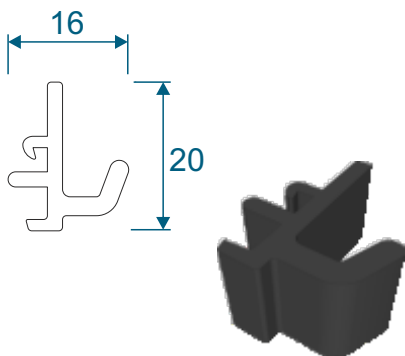

VS032 - Internal PVC Interlock

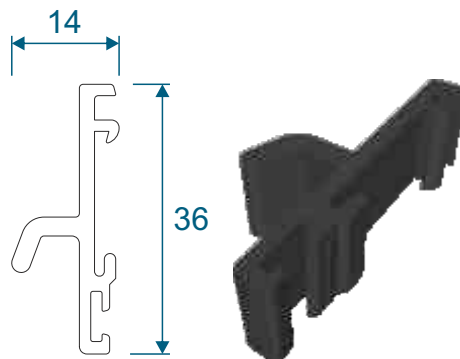

VS041 - Wool Pile Carrier

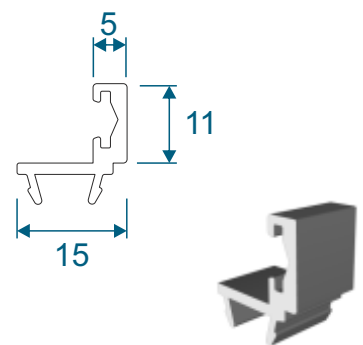

ZSB98 - A-Shaped Bar

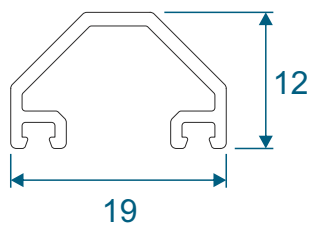

ZSB99 - Fixing Plate

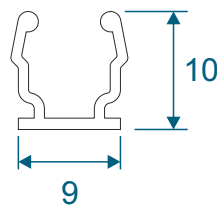

W20165 - 25mm Flat Astragal

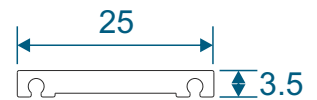

Sections

Head Section

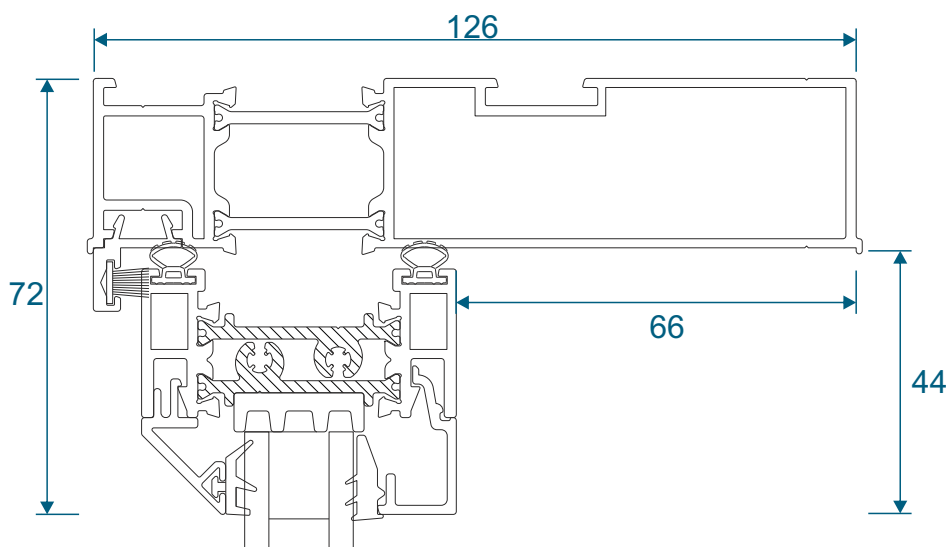

Midrial / Interlock Section

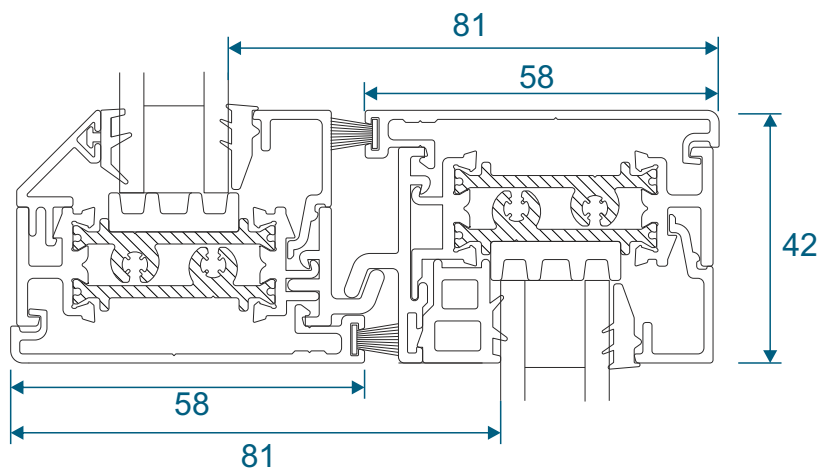

Cill Section

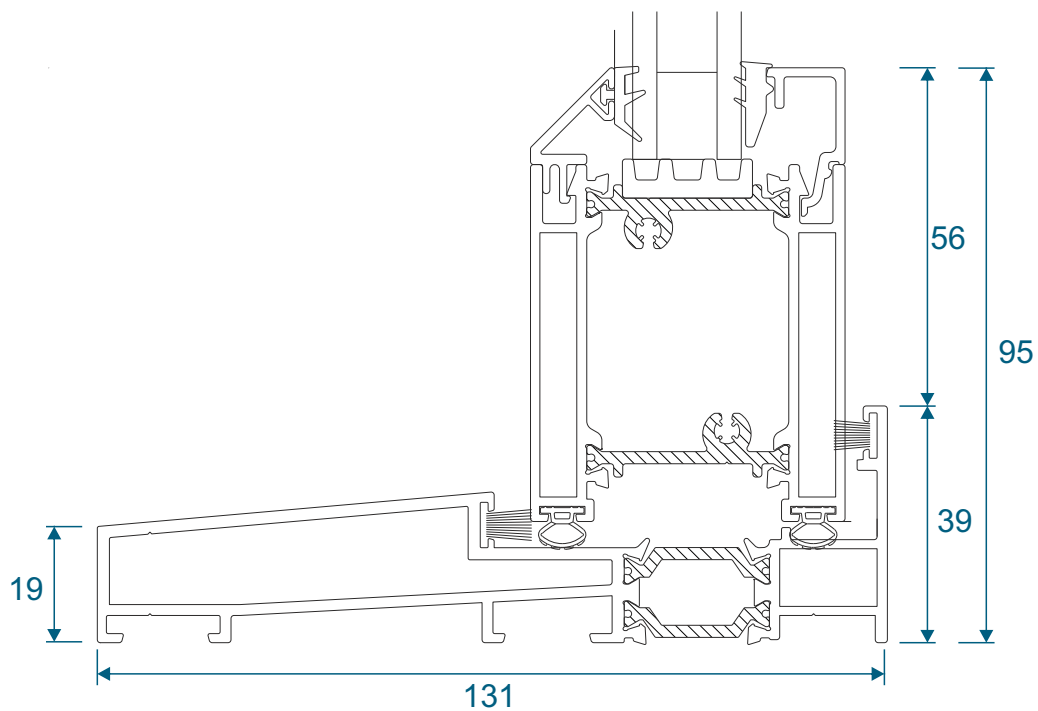

Sections

Jamb

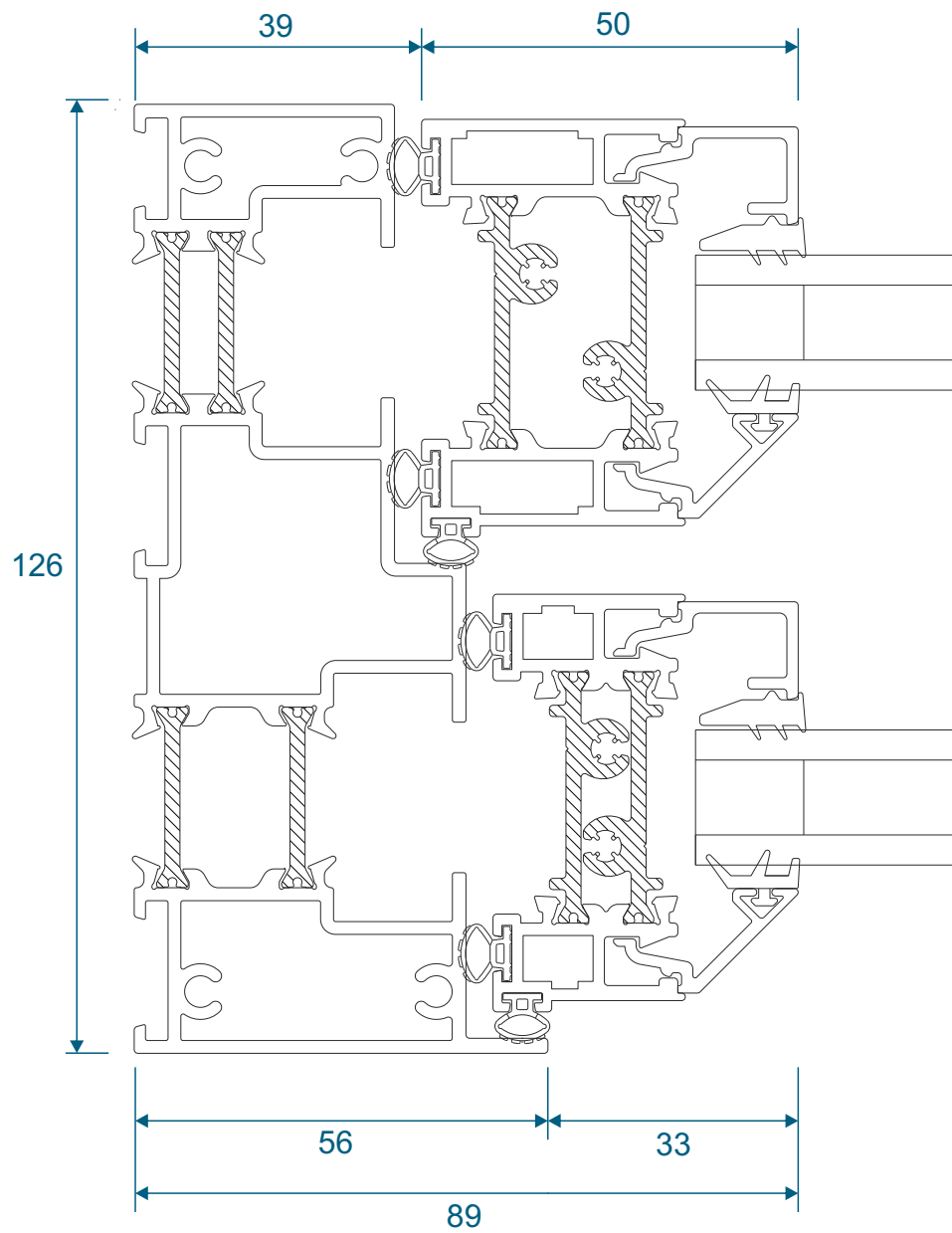

Astragal Bars

'A' Shaped Out And In

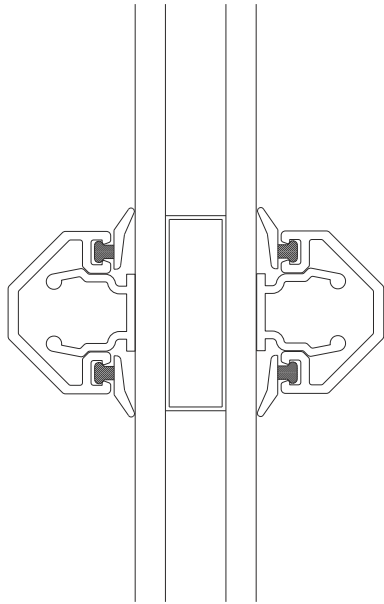

'A' Shaped Out / 25mm Flat In

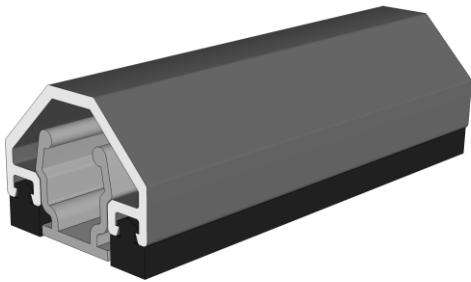
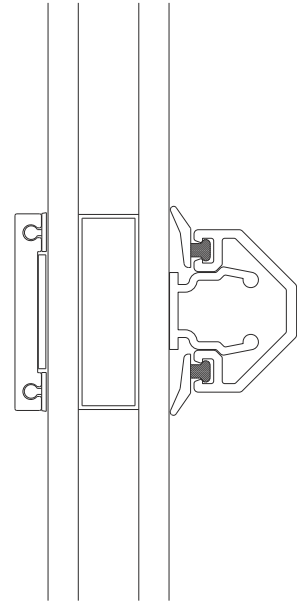

Main Office & Factory

Units 4-5, t: 01268 681612 (15 lines)
Charfleets Road, f: 01268 510058
Canvey Island, e: sales@duration.co.uk
Essex. SS8 0PQ w: www.duration.co.uk

Grand Design Exhibition Centre

Unit 1 Casino Parade, t: 01268 695100
Eastern Esplanade,
Canvey Island, SatNav Directions
Essex. SS8 7FJ Use: SS8 7DN.