









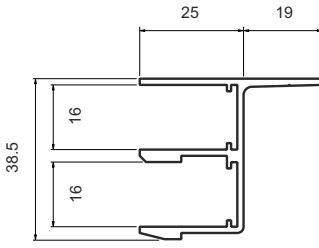
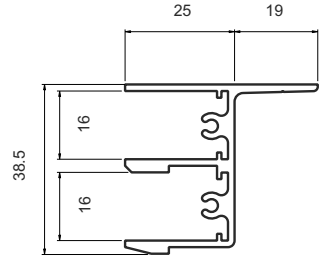
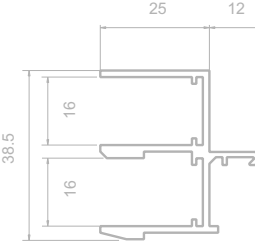
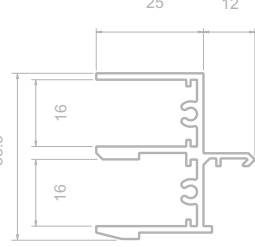
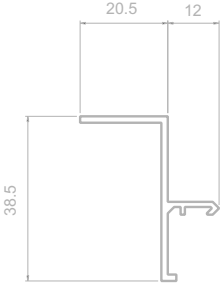
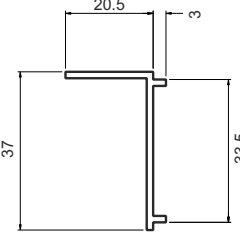
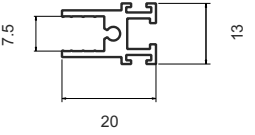
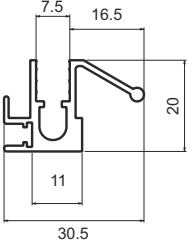
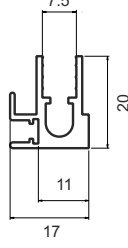
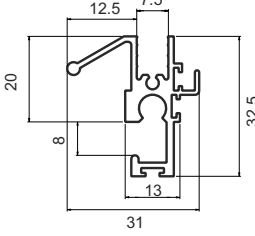

DURATION WINDOWS

Vertical Sliding Secondary Glazing Economy Odd Leg System Section Identification

Contents

- Section Identification Overview Page 2
- Outerframes Page 3
- Sliding Panels Page 4
- Non-Aluminium Parts Page 5
- Unbalanced Vertical Sliders Page 6
- Balanced Vertical Sliders Page 8

Overview

<p>Odd Leg Outerframe</p> <p>SG 91 Odd Leg Outerframe no screw ports</p>  <p>SG 92 Odd Leg Outerframe with screw ports</p> 	<p>Subframe Outerframe</p> <p>SG 52 Subframe Fix Outerframe no screw ports</p>  <p>SG 53 Subframe Fix Outerframe with screw ports</p> 	<p>Outerframe Bottom (Cill)</p> <p>SG 65 Subframe Fix Outerframe Bottom</p>  <p>SG 87 Odd Leg Outerframe Adaptor</p> 
<p>Sliding Panels</p> <p>SG 64 Sliding panels</p> 	<p>Vertical Sliding Panel Interlocks</p> <p>SG 61 Interlock with handrail</p>  <p>SG 62 Interlock</p>  <p>SG 63 Extended Bottom Panel & Interlock</p> 	
<p>Non-Aluminium Parts</p> <p>Wooden Suframes</p>  <p>SF 1</p>  <p>SF 3</p>  <p>SF 4</p> <p>Balances</p>  <p>SG 55 PVCU Track</p>  <p>Nylon Skids</p>  <p>Spring Catch</p> 		



Outerframe

SG 91
Odd Leg Outerframe
no screw ports

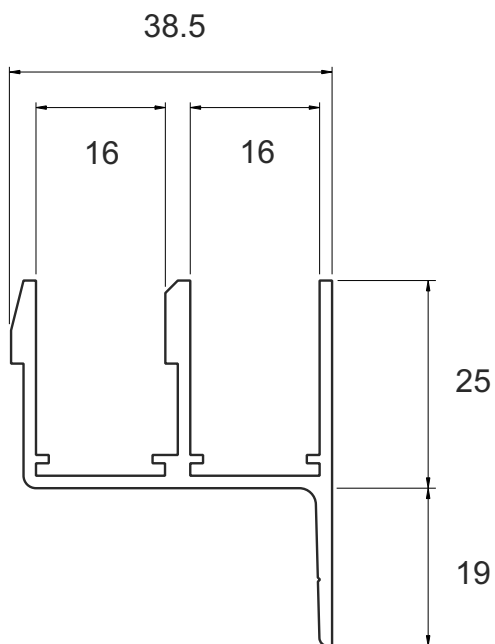

SG 87
Odd Leg Outerframe
Adaptor

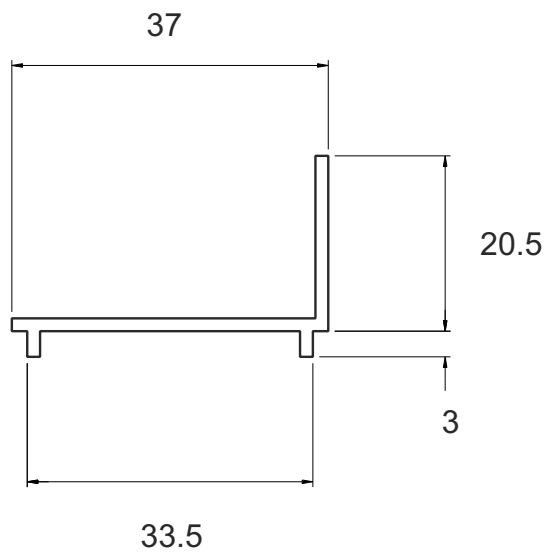

SG 92
Odd Leg Outerframe
with screw ports

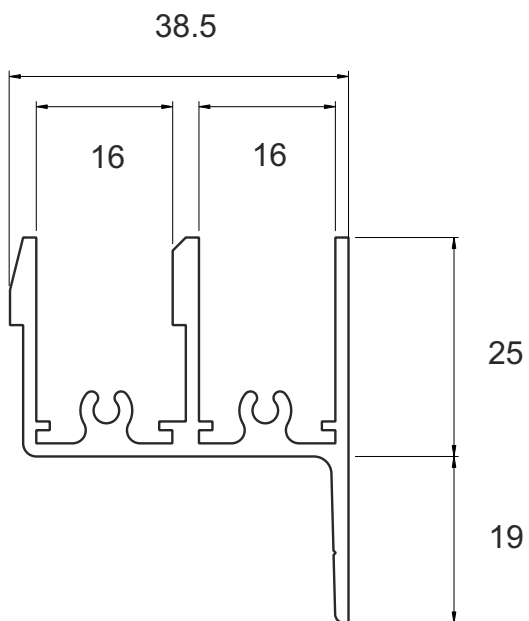



Sliding panels

SG 61
Interlock
with handrail

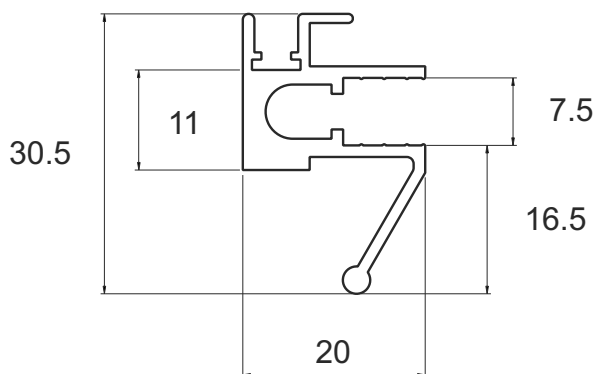

SG 62
Interlock

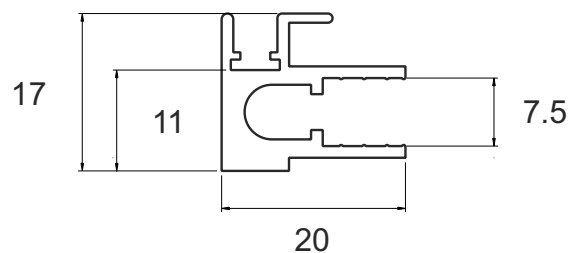

SG 63
Extended Bottom
Panel & Interlock

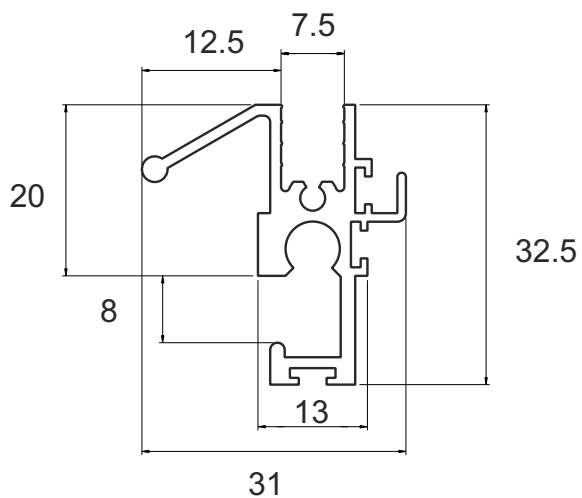

SG 64
Sliding panel

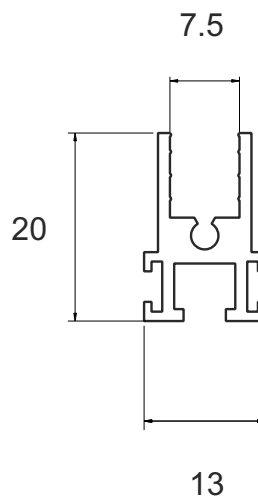



Non-Aluminium Parts

SG 55
PVCU Track

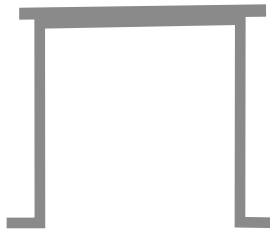

Balances

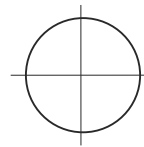

Nylon Skids



Spring Catch

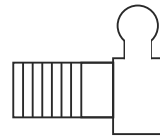



Unbalanced Vertical Slider - Cross Section

Economy Odd Leg

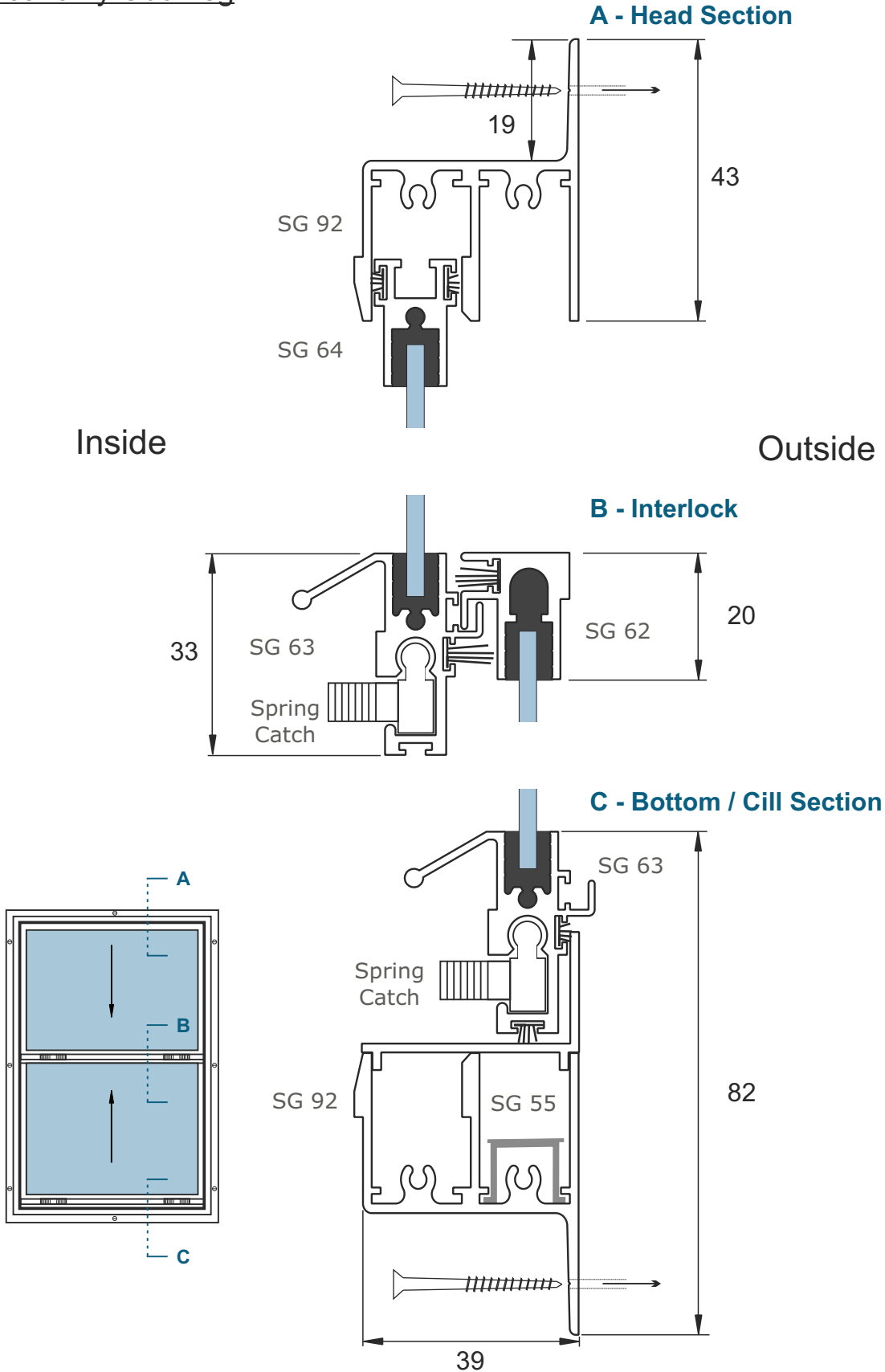

Unbalanced - Plan View

Economy Odd Leg

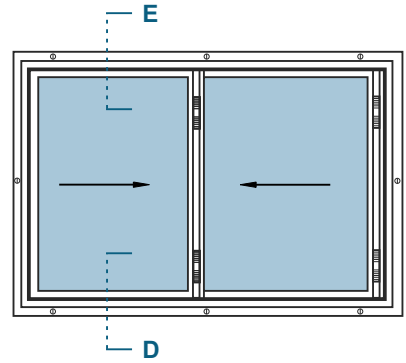
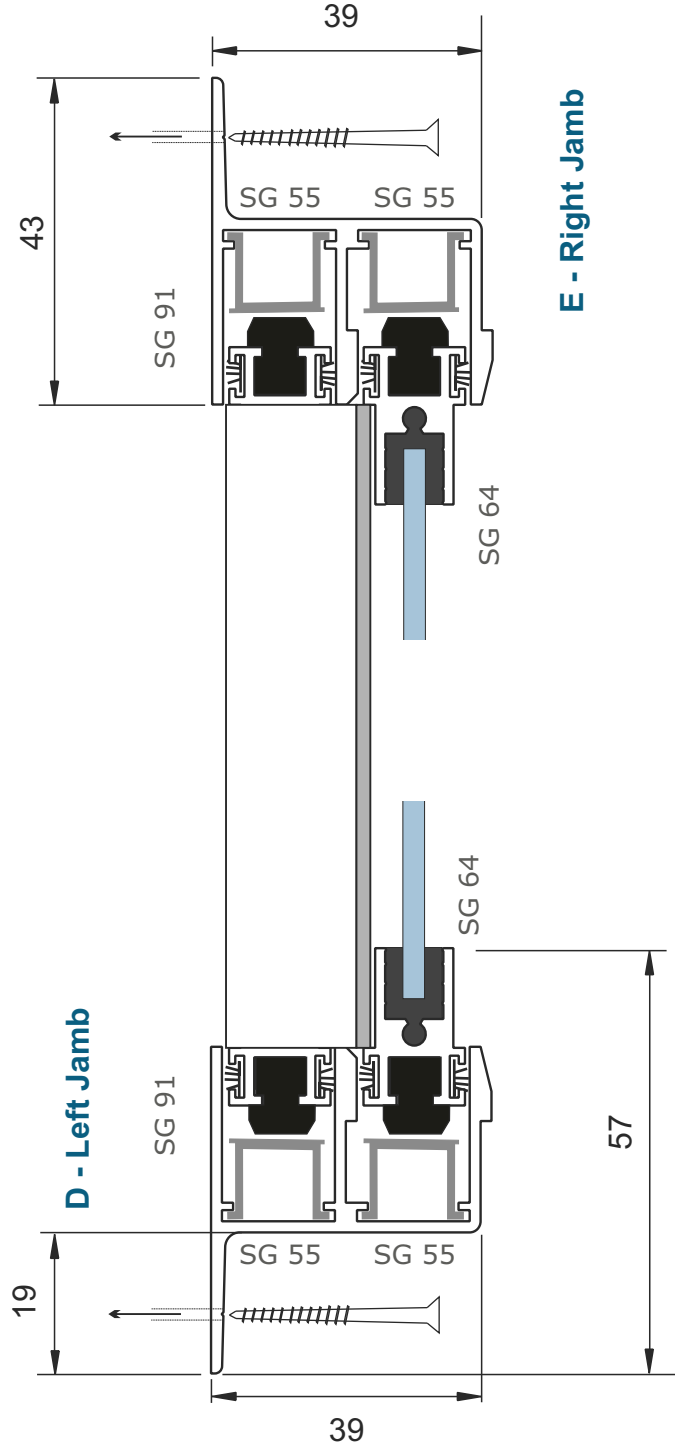



Balanced Vertical Slider - Cross Section

Economy Odd Leg

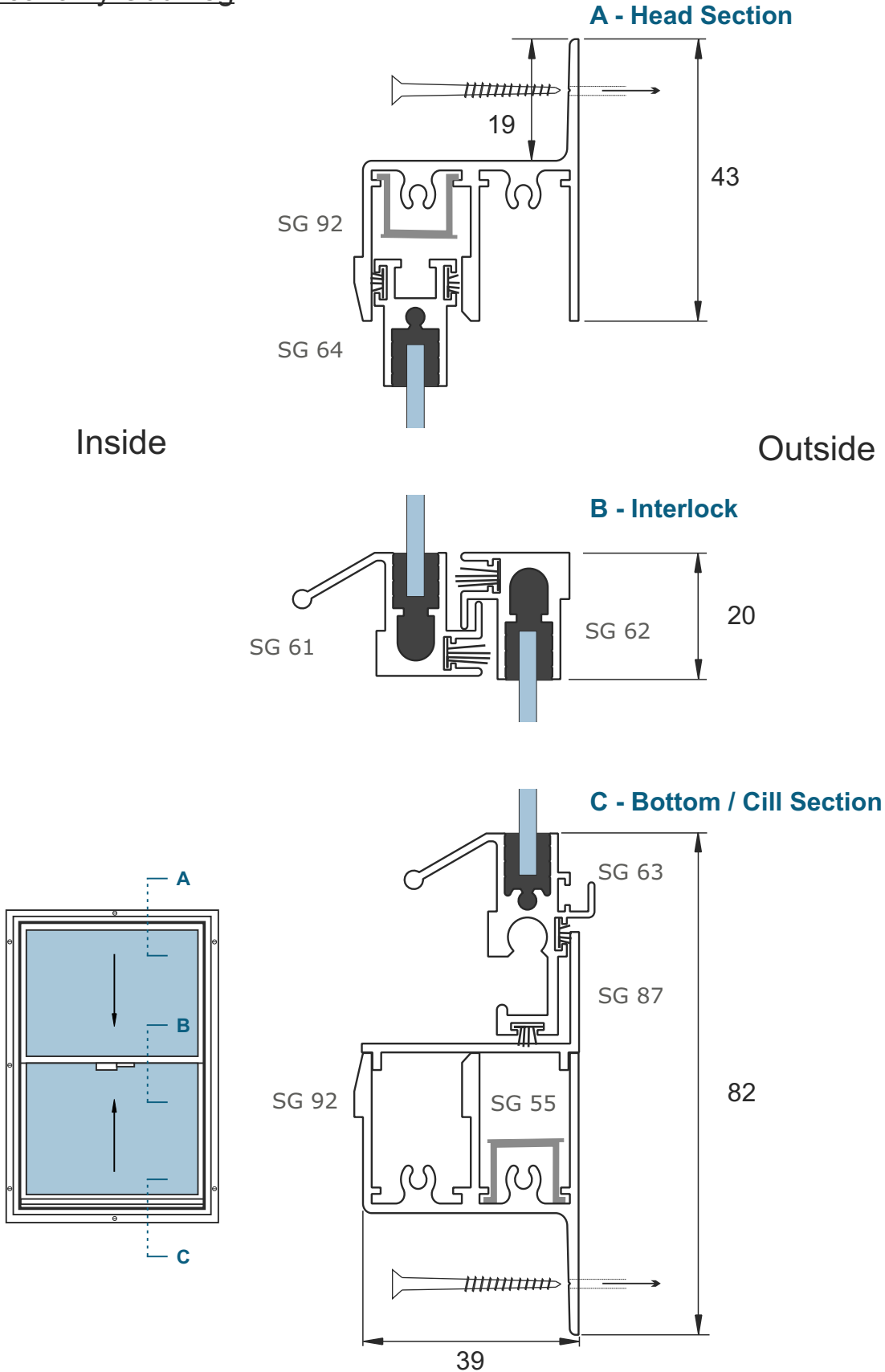

Balanced - Plan View

Economy Odd Leg

